

QUICK START GUIDE



For a full version of the manual visit gastech.com/d-guard2



t +61 8 6108 0000

e info@gastech.com

w gastech.com



support

HEAD OFFICE
24 Baretta Road
Wangara WA 6065
Phone: +61 8 6108 0000

SYDNEY OFFICE
Suite G01, 10 Tilley Lane
Frenchs Forest NSW 2086
Phone: +61 2 9451 0054

BRISBANE OFFICE
PO Box 59
Kippa-Ring QLD 4021
Phone +61 7 3160 0901

[gas detection](#) | designed for support | gastech.com



9 SPAN CALIBRATION

Step 1. Use for auto span.

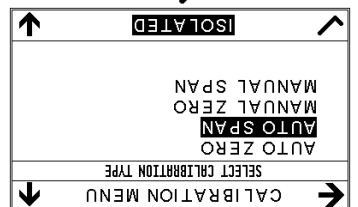

Step 2. Use to continue.

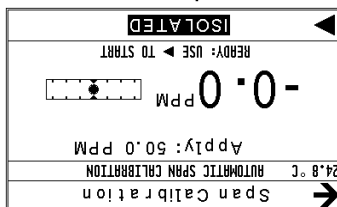

Step 3. Use to save.

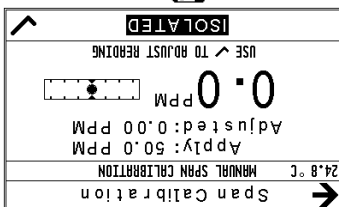

Step 4. Use to exit.

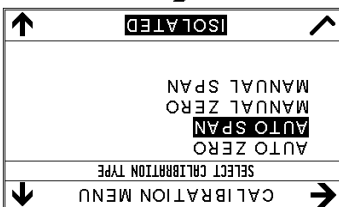

8 ZERO CALIBRATION

Step 1. Use for auto zero.

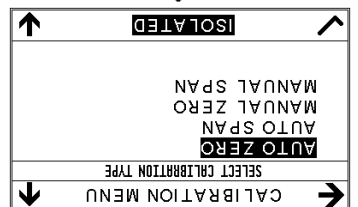

Step 2. Use to start.

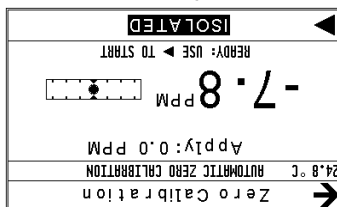

Step 3. Use to save.

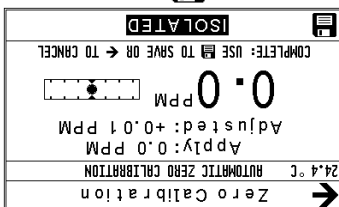

Step 4. Use to exit.

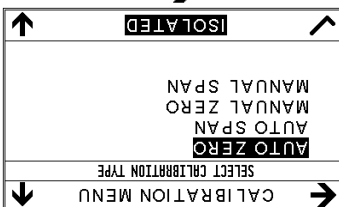

QUICK START GUIDE

D-GUARD²

1 INSTALLATION

Make sure the gland faces the ground.

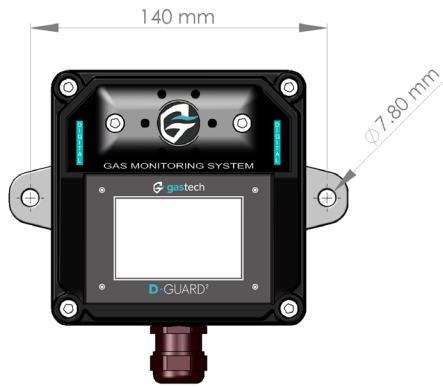

2 OPEN THE CASE

Use the Service Tool to loosen the four screws which hold the lid on.

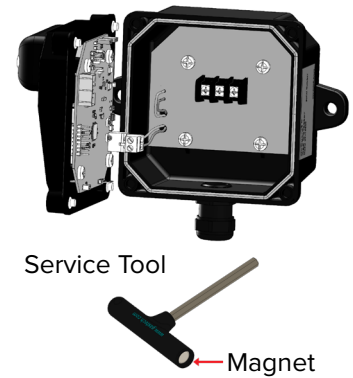

WARNING: The D-Guard² must be installed by an approved person. Incorrect installation can cause injury or death to personnel.



Read the instruction manual.

3 ELECTRICAL INSTALLATION

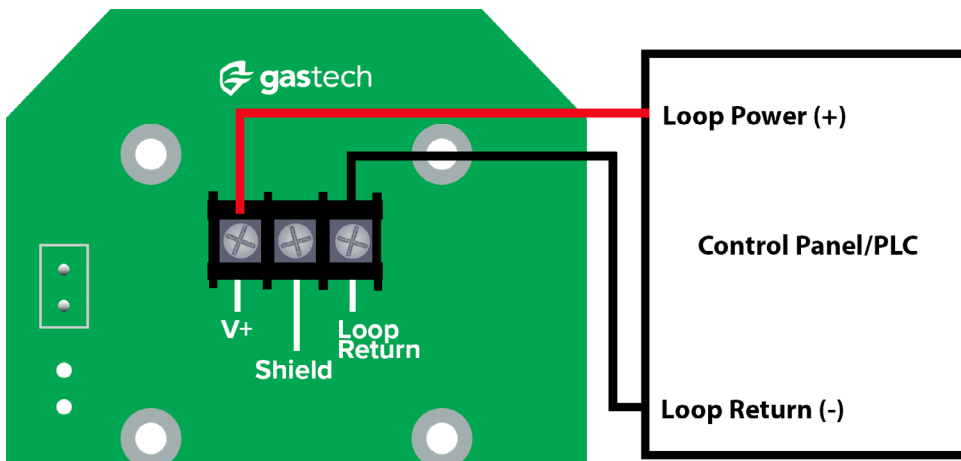

Connect the D-Guard² to a DC supply voltage of 13-28V. Make sure the outer diameter of the cable sheath is between 10 and 14 mm to allow the gland to seal properly.

4 SPLASH SCREEN



5 WARM-UP SCREEN

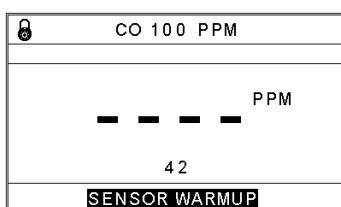

6 UNLOCK THE MENU SCREEN

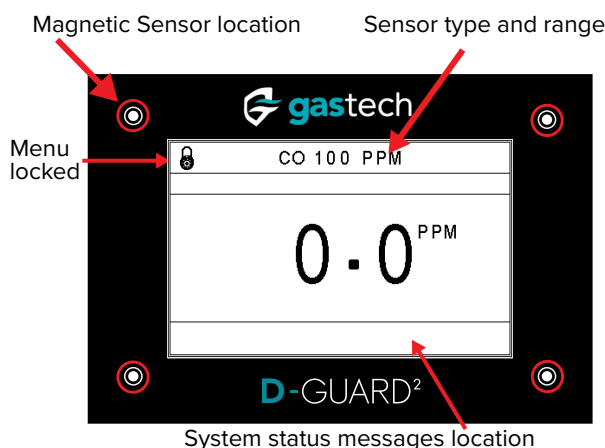

Put the Service Tool over the magnetic sensor location to activate the user menu.

7 ACCESS CAL MENU

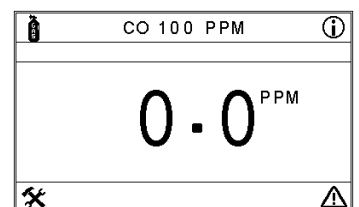

Step 1. Use to enter menu.

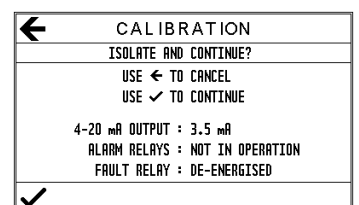

Step 2. Use to continue.