

UNI

Single-Gas Detectors

MP100

User's Guide



Contents

1.	General Information.....	3
2.	User Interface.....	3
3.	Display.....	4
4.	Operation.....	5
4.1	Turning the Unit On and Off.....	5
4.2	Warm-up Sequence.....	5
4.3	Normal User Mode.....	5
4.3.1	Real Time Readings.....	5
4.3.2	STEL.....	6
4.3.3	TWA.....	6
4.3.4	Peak.....	6
4.3.5	Minimum (Oxygen Sensor Only).....	6
4.3.6	Alarm Log.....	6
4.3.7	Backlighting.....	6
4.4	Configuration Mode.....	7
4.4.1	Entering and Exiting Config Mode.....	7
4.5	Sensor Calibration and Bump Test.....	7
4.5.1	Zero (Fresh Air) Calibration.....	7
4.5.2	Span Calibration.....	8
4.5.3	Bump Test.....	9
4.6	Setting Instrument Configurations.....	9
4.6.1	Alarm Limits.....	9
4.6.2	Oxygen Monitors.....	10
4.6.3	Span Value.....	10
4.6.4	Bump/Cal Intervals.....	10
4.6.5	Gas Concentration Unit.....	10
4.6.6	Vibrator Enable/Disable.....	11
4.6.7	Power-on Zero Enable/Disable.....	11
4.6.8	Fast Power-on Enable/Disable.....	11
4.6.9	Configuration Reset.....	11
5.	Computer Interface.....	12
6.	UNI Docking Box (MP100T) Calibrations.....	14
6.1	Docking Box Set-up.....	14
6.2	Docking Box Gas Connection and Calibration Process.....	15
6.3	Docking Box Data Download and Calibration Certificates.....	16
7.	Maintenance and Specifications.....	18
7.1	Battery Replacement.....	18
7.2	Sensor Filter Replacement.....	19
7.3	Sensor Replacement.....	19
7.4	Troubleshooting.....	20
7.5	Alarm Signal Summary.....	21
7.6	Sensor Specifications and Default Configurations.....	23
7.7	Instrument Specifications.....	24

Read Before Operating

This manual must be carefully read by all individuals who have or will have the responsibility of using, maintaining or servicing this product. The product will perform as designed only if it is used, maintained and serviced in accordance with the manufacturer's instructions.

WARNING !

- Never operate the monitor when the cover is removed.
- Remove the monitor cover and battery only in area known as non-hazardous.
- Use only mPower's lithium battery part number M500-0001-000 [1.17.02.0002] (3.6V, 2700mAH, AA size) or part No. ER14505 cell manufactured by EVE Energy Co., LTD
- This instrument has not been tested in an explosive gas/air atmosphere having an oxygen concentration greater than 21%.
- Substitution of components will impair suitability for intrinsic safety.
- Substitution of components will void warranty.
- It is recommended to bump test with a known concentration gas to confirm the instrument is functioning properly before use.
- Before use, ensure that the colorless ESD layer on the display is not damaged or peeling. (The blue protective film used for shipment may be removed.)

AVERTISSEMENT !

- N'utilisez jamais le moniteur lorsque le couvercle est enlevé.
- Retirer le couvercle du moniteur et la batterie uniquement dans une zone connue comme non dangereuse.
- Utilisez uniquement la batterie au lithium de mPower, pièce No. M500-0001-000 [1.17.02.0002] (3.6V, 2700mAH, taille AA) ou celle de EVE Énergie Cie., Lté, pièce No. ER14505.
- Cet instrument n'a pas été testé dans une atmosphère explosive gaz / air ayant une concentration en oxygène supérieure à 21%.
- La substitution de composants compromettra l'aptitude à la sécurité intrinsèque.
- La substitution des composants annulera la garantie.
- Il est recommandé de tester avec un gaz de concentration connu pour confirmer que l'instrument fonctionne correctement avant de l'utiliser.
- Avant l'utilisation, assurez-vous que la couche ESD incolore de l'écran n'est pas endommagée ou épluchée. (Le film protecteur bleu peut être enlevé.)

Proper Product Disposal at The End Of Life



The Waste Electrical and Electronic Equipment (WEEE) directive (2002/96/EC) is intended to promote recycling of electronic equipment and their components at end of life. This symbol (crossed-out wheeled bin) indicates separate collection of waste electrical and electronic equipment in the EU countries. This product may contain one or more Nickel-metal hydride (NiMH), Lithium-ion, or Alkaline batteries. Specific battery information is given in this user guide. Batteries must be recycled or disposed of properly. At the end of its life, this product must undergo separate collection and recycling from general or household waste. Please use the return and collection system available in your country for the disposal of this product.

1. General Information

The UNI (MP100) is a single sensor, portable, personal toxic gas monitor. It displays gas concentration continuously on a big segment LCD. It also monitors the STEL, TWA, Peak and Minimum (for O₂ only) values, and these can be displayed on demand. High, Low, STEL and TWA alarm thresholds are configurable. The shell is made of high strength, durable material. The two-key operation is simple to use. Sensor and battery can be replaced easily. Calibration is also very convenient.

2. User Interface

1. Audible Alarm Port
2. LED alarm window
3. LCD
4. Left Key (Confirm/Number increasing)
5. Right Key (Power On-Off/ Cursor moving)
6. Alligator clip
7. Sensor Gas Inlet
8. Vibrator



3. Display

1. Gas name, if CO, H₂S, or O₂ (others on label on back side)
2. Question mark (to confirm action)
3. Unit status indicator "OK" and to confirm entry
4. Gas unit, includes: $\times 10^{-6}$, ppm, %, mg/m³, $\mu\text{mol/mol}$
5. Battery charge status
6. HIGH, LOW, STEL, TWA alarm indicator (when flashing)
7. Span calibration (in process or due)
8. Zero calibration (in process or due)
9. Concentration reading or other parameter

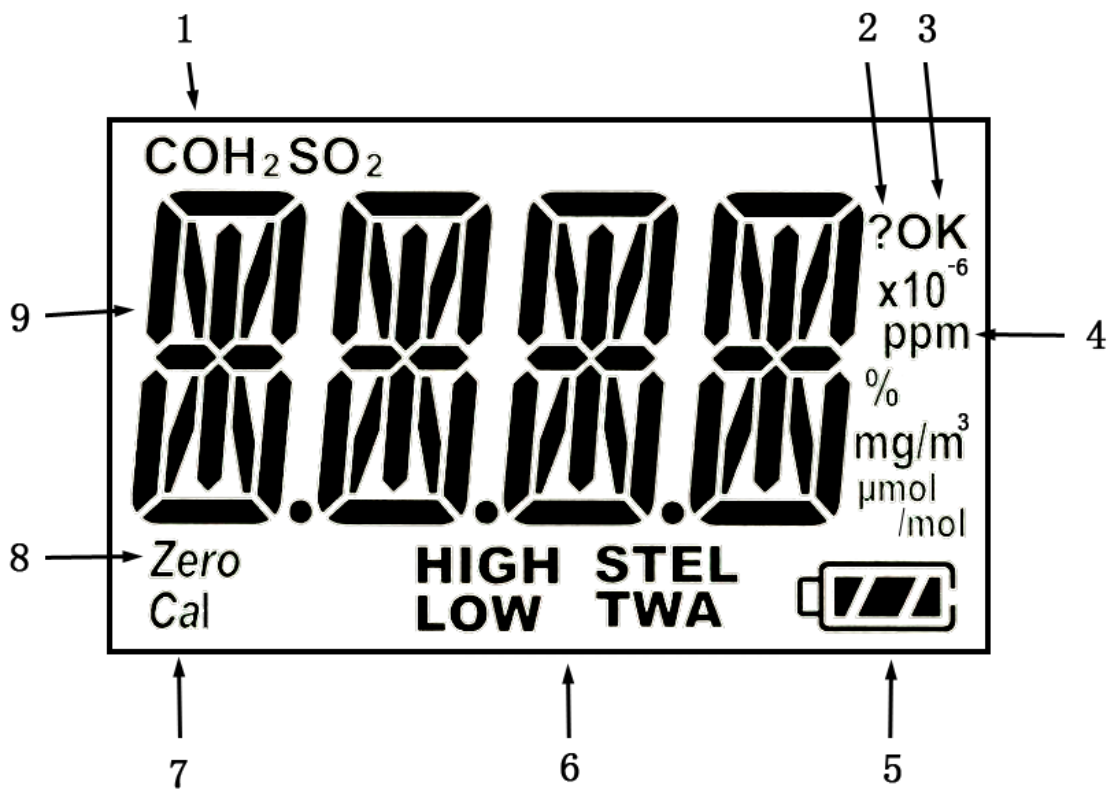

4. Operation





4.1 Turning the Unit On and Off

Press and hold the Right Key for 3 seconds, until the red light, buzzer, and vibrator all trigger, followed by the green light, and the LCD displays “On”. To turn off, press and hold the Right Key from normal display mode for a 5-second count-down, until the unit displays “Off”.

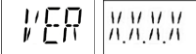
4.2 Warm-up Sequence

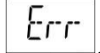
After powering on, the unit enters a warm up and self-test sequence, shows the firmware version

as follows: 

- If the sensor cannot be identified or is not installed, the screen alternately displays  and .
- If the **Bump** or **Cal Due** setting is enabled and the due date has passed, the display will alternate between  or  and . The Left Key must be pressed to acknowledge, otherwise the instrument will turn itself off automatically after 30s. Enter Configuration Mode (see below) to perform bump or calibration. If the battery has been removed or replaced, be sure to use mPower uite to reset the instrument clock before bump or calibration.

Lastly, the following values will be shown accordingly:

- High alarm threshold
- Low alarm threshold
- STEL (short-term exposure limit) alarm threshold
- TWA (8-hour time-weighted average) alarm threshold

4.3 Normal User Mode

4.3.1 Real Time Readings

When warm-up is complete, the unit enters normal mode and starts displaying instantaneous gas concentrations.



By pressing the Right Key the user can check other values including STEL, TWA, PEAK, MIN (for O₂ only) and Alarm Log. The display returns to real time readings from any other screen if there is no key action for 60 seconds.

UNI MP100 User's Guide

4.3.2 STEL

This displays the Short Term Exposure Limit (STEL) calculation, which is the average concentration in a moving window over the previous 15 minutes. The STEL value rises and falls with some lag time over the instantaneous reading. A STEL alarm cannot be cleared except by turning the unit off and back on, but will clear automatically after 15 minutes in clean air.

4.3.3 TWA

This displays the Time-Weighted Average (TWA) calculation, which is the average concentration times the fraction of 8 hours that the instrument has been on. The TWA value is similar to a dose in that it rises but never falls, until it is reset by turning the unit off. Likewise, a TWA alarm cannot be cleared except by turning the unit off and back on.



4.3.4 Peak

The Peak screen shows the highest value since the unit was turned on.

Press the Left Key to enter the Clear Peak screen and Press the Left Key again to acknowledge and clear the Peak value.

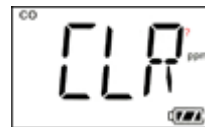

4.3.5 Minimum (Oxygen Sensor Only)

The Minimum screen is used for the oxygen sensor only and shows the lowest value since the unit was turned on.

Press the Left Key to enter the Clear Min screen and Press the Left Key again to acknowledge and clear the Min value.

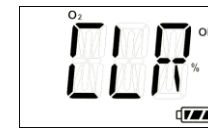
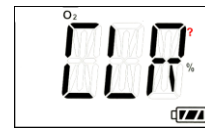

4.3.6 Alarm Log

Up to 50 alarm events lasting ≥ 5 seconds are logged into memory and the last 10 such events can be viewed on the instrument. When A 1 is reached using the Right Key, it flashes between the A 1 screen and a screen showing the

alarm concentration and type. Values preceded by a "--" with no alarm label indicate a negative concentration alarm event. Use the Left Key to cycle through the 10 available alarms. To view all 50 alarm events along with date and time stamps, it is necessary to use a Docking Box or CaliCase connected to a computer with mPower Suite software.

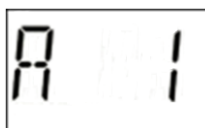

4.3.7 Backlighting

Holding down the Left Key for a few seconds causes the red alarm LEDs to flash for 5 seconds. This helps the user read the display when in darkness.





4.4 Configuration Mode

In Config mode, the user can change parameters and calibrate the unit. In general, use the Left Key to increase the number or confirm an operation, and use the Right Key to move the cursor or go to the next menu item.

4.4.1 Entering and Exiting Config Mode

Press and hold the Left Key and the Right Key together for 3 seconds until the password screen

is displayed,  followed by , with one digit or cursor flashing, to prompt the user to enter the password. The default password is 0000. Use the Left Key to increase the number, and the Right Key to move the cursor, and the Left "OK" Key again to accept the password input and enter Config mode. If the digit input is incorrect, use the Right Key to move the cursor and Left Key to change the input.

NOTE: The MP100 default password is 0000.

To exit Config Mode, press the Right Key until  is displayed, and acknowledge with the Left Key to return to Normal Mode. Alternatively, just wait for one minute and the unit will automatically revert to Normal Mode.



4.5 Sensor Calibration and Bump Test

Before the unit can monitor gas correctly, it needs to be calibrated using zero and span gas. Calibration and Bump Tests are recorded in the instrument datalog for compliance purposes.

4.5.1 Zero (Fresh Air) Calibration

Zero calibration sets the baseline for the sensor. It is preferably done in fresh air at the same ambient temperature and humidity as will be used for measurements. However, nitrogen, dry cylinder air, or other gas source known to be free of detectable compounds can also be used. One exception is that for an oxygen (O₂) sensor the Fresh Air Calibration sets the value to 20.9%, so air must be used.

From the  menu, press the Left Key to start a zero calibration. The unit displays a 15-

second count-down followed by the calibration result as either  or . The user can

abort the zero calibration during the count-down by pressing the Right Key, after which  is displayed.





4.5.2 Span Calibration

Span calibration determines the sensitivity of the sensor to the gas. Recommended calibration gases and concentrations are listed in Section 7.6 at the end of this manual and in TA Note 4 (available at www.mpowerinc.com). Special calibration procedures for highly reactive gases are described in TA Note 6. Oxygen sensor calibration is reversed from other sensors and uses pure nitrogen with 0% oxygen during the span procedure and 20.9% oxygen (air) during the fresh air “zero” procedure. We recommend using a fixed flow regulator of at least 0.3 LPM but no more than 0.6 LPM. Use as short tubing connections as possible.

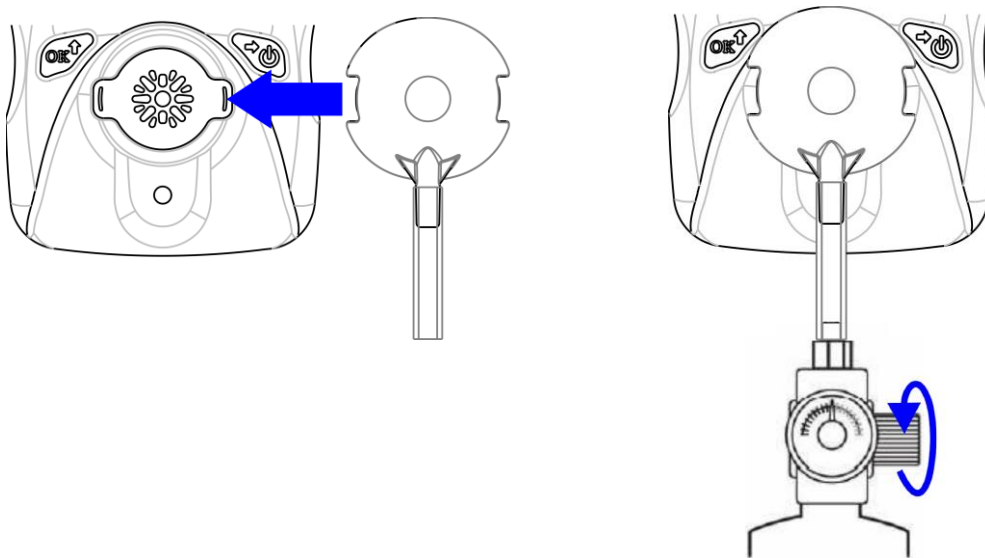
Span Calibration Procedure

1. Connect the Calibration Adapter to the span gas cylinder's regulator and snap it into place over the UNI sensor.



2. Enter the  menu, start the gas flow, and press the Left Key to start the calibration count-down. The calibration time is typically 60 seconds but may be shorter or longer depending on the sensor type.
3. To abort the span calibration during count-down, press the Right Key and  is displayed.
4. After count-down, the span calibration result  or  is displayed.
5. Turn off the gas supply and remove the Calibration Adapter.



CAUTION

During normal monitoring, never operate the MP100 with the Calibration Adaptor attached because it will block diffusion of gas into the sensor.

UNI MP100 User's Guide

4.5.3 Bump Test

A Bump Test is a quick check to ensure that the sensor and alarms are working properly. It is done with the same gas as is used for span calibration. Enter the  menu, start the gas flow, then press the Left Key to start bump count-down (typically 45 seconds, but varies with sensor).

After count-down, the bump test result  or  is displayed.

To abort the bump test during count-down, press the Right Key and  is displayed.

Although a Bump Test is a recorded event in the datalog, the user can always do an unrecorded bump check such as by breathing into an oxygen monitor just to verify that the sensor and alarms are functioning.

4.6 Setting Instrument Configurations

4.6.1 Alarm Limits

MP100 toxic gas monitors alarm with 2 beeps & flashes per second when concentrations are over the Low Alarm setpoint, and 3 beeps & flashes per second when over the High Alarm setpoint. See Section 7.5 for a summary of alarm signals and Section 4.6.2 for Oxygen Monitor alarms.

All the preset alarm limits, HIGH, LOW, STEL & TWA can be changed. From these menus

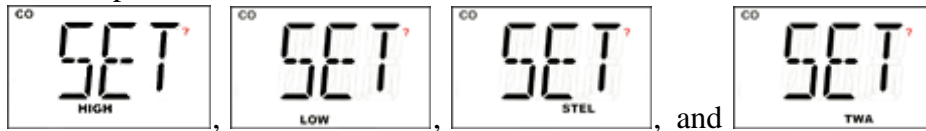

, press the Left Key to change the corresponding alarm limit, using the same process as for entering a password (Section 4.4.1):

The current setting value is displayed, with the first digit flashing:



Use the Left Key to increase the current digit, cycling from 0 to 9:



Use the Right Key to move the cursor to the next digit:



After all digits are entered, use the Right Key to move to the "OK" symbol, and press the Left Key to save the entry. The unit will display SAVE for a few seconds while storing the value; it is not necessary to press OK to initiate saving.



UNI MP100 User's Guide

Silence Mode can be entered using mPower Suite (Section 5). In this mode, the audio alarm is disabled when exceeding the Low Alarm, with no change to the visual and vibration alarms. The audio alarm is still enabled when exceeding High, STEL, TWA or Overrange Alarm conditions.

NOTE 1: The MP100 will show an error message “Err” if:

- The Low alarm is attempted to be set higher than the high alarm setting.
- The High alarm is attempted to be set lower than the low alarm setting.
- The entered value is outside the measuring range.

4.6.2 Oxygen Monitors

Standard Oxygen Monitors: Oxygen monitor alarms function differently than toxic gas monitor alarms in that the normal ambient air reading is 20.9% and an alarm is triggered when the reading goes BELOW the Low alarm setpoint or ABOVE the High Alarm setpoint. Oxygen monitors do not have STEL or TWA alarms.

Inert Oxygen Monitors: Oxygen monitors programmed for inert gas applications do not alarm when the O₂ concentrations are below the Low Alarm setpoint or above 19.5%. They give a Low Alarm (2 beeps/sec) when between the Low and High Alarm setpoints and a High Alarm (3 beeps/sec) when between the High Alarm setpoint and 19.5%. The default Low and High alarm setpoints are 4% and 5%, respectively, but can be adjusted, while the 19.5% limit is fixed. Thus, this version is useful both for oxygen deficiency monitoring in normal ambient air when users do not wear a breathing apparatus, and in inert gas environments, where breathing apparatus are required, to warn of high oxygen levels that may allow explosion to occur.

4.6.3 Span Value

The span gas concentration can be changed from the Cal SET menu using the same process as for setting alarm limits.

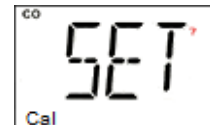

NOTE: The MP100 will show an error message “Err” if:

- The Span setting is less than 5% of the measuring range or greater than the measuring range.
- For the Oxygen sensor, the span setting is greater than 19.0%.



4.6.4 Bump/Cal Intervals

In the Bump and Cal Interval menus, the LCD alternates between:  and , or 

and . Press the Left Key to enter the menu and change the interval using the same process as for setting alarm limits. Note that a value of 0 means Bump or Cal notifications are turned off.

NOTE: The MP100 will show “Err” if the interval is out of the valid range: 0-180 day(s).

4.6.5 Gas Concentration Unit

The gas concentration unit menu alternates between  and . Press the Left Key to enter the gas unit sub-menu, showing the currently selected unit blinking. Unit options include x10⁻⁶, ppm, mg/m³ and μmol/mol for toxic gas sensors, and % for oxygen. Use the Right Key to scroll through the unit list and select, and the Left Key to confirm and exit.

4.6.6 Vibrator Enable/Disable

The vibrator consumes a lot of power and can be disabled to extend the battery life. The Vibrator menu alternates between `VIB` and `SET`. Press the Left Key to change the vibrator enable/disable status. The current vibrator status is displayed, alternating between `VIB` and `on` if enabled, or between `VIB` and `off`, if disabled. Use the Right Key to change the status, and use the Left Key to confirm and exit.

4.6.7 Power-on Zero Enable/Disable

The sensor baseline may shift due to changes in environment conditions, such as temperature or humidity, and require a zero calibration. The MP100 can prompt the user to zero calibrate every time the unit is powered on, and this feature can be enabled/disabled.

The Power-on Zero menu alternates between `P-on` and `SET`. Press the Left Key to change the power-on zero enable/disable status. The current status is displayed, alternating between `P-on` and `on` if enabled, or between `P-on` and `off` if disabled. Use the Right Key to change the status, and the Left Key to confirm and exit. When the unit is re-started and user is prompted with `AIR` to zero, it must be initiated within 30 s or else the zeroing is skipped.

4.6.8 Fast Power-on Enable/Disable

If fast startup is enabled, the screens showing HIGH/LOW/STEL/TWA alarm threshold values will be skipped during warm up sequence. On start-up, the unit shows the firmware version number and then goes directly to concentration readings.

The fast power-on menu alternates between `FAST` and `SET`. Press the Left Key to change the fast startup enable/disable status. Enable or disable Fast Power-on and confirm the status using the same process as for Vibration Alarm or Power-on Zero enable/disable.

4.6.9 Configuration Reset

If some unit parameters are incorrect and the user has difficulty correcting them, this menu can be used to set the all the configuration parameters back to the factory default condition. From the alternating `RST` and `CFG` display, press the Left Key to enter the `REST` (reset) menu. Then press the Left Key to confirm or the Right Key to abort the reset.

5. Computer Interface

Computer interface requires a UNI IR Reader, Single Docking Box or CaliCase Docking Station connected to a PC fitted with mPower Suite software. mPower Suite can be used to 1) download logged alarm and calibration events, 2) print calibration certificates, 3) upload configuration parameters to the instrument and 4) upgrade the instrument firmware. mPower Suite and instrument firmware can be downloaded from the website at <https://www.mpowerinc.com/software-downloads/>.

1. Connect the USB cable to both the PC and the IR Reader or Docking Box.
⚠WARNING! Connect only in non-hazardous environments!
2. Turn on the instrument and attach the IR Reader or insert it face down into the Docking Box.
3. Start mPower Suite on the PC and click the “Search” button on the bottom panel.
4. Find the instrument in the left bar Device Connected list. Click on the S/N to get the configuration file from the instrument.
5. Edit the configuration parameters as desired and click “Write” to upload the configuration to the instrument.
6. “Read” downloads the current configuration file from the instrument.
7. “Save” stores the current configuration file to the PC.
8. “Load” calls up a stored configuration file from the PC to mPower Suite.
9. To update the instrument firmware, select “Firmware Upgrade”. The firmware must first be downloaded to the PC from the mPower website www.mPowerinc.com.

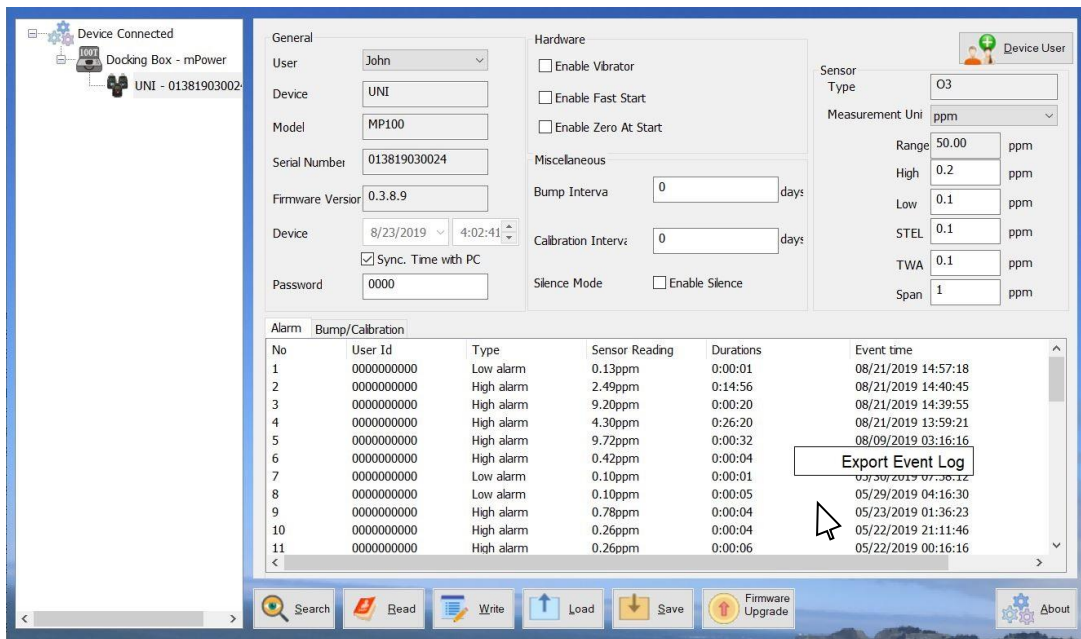

mPower Suite Screen

UNI MP100 User's Guide

10. Alarm Events are shown in the bottom half panel and Bump/Calibrations times can be viewed by clicking on the corresponding tab.
11. To export data to a csv file readable by Excel or other spreadsheet software, move the cursor over the bottom data panel, right-click the mouse, and then select "Export Event Log".

The screenshot displays the UNI MP100 software interface. On the left, a tree view shows 'Device Connected' with 'Docking Box - mPower' and 'UNI - 01011807004'. The main area is divided into several sections: 'General' (User, Device, Model, Serial Number, Firmware Version, Device date/time, Password), 'Hardware' (Enable Vibrator, Enable Fast Start, Enable Zero At Start), 'Miscellaneous' (Bump Interval, Calibration Interval, Silence Mode), and 'Sensor' (Type: CO, Measurement Unit: ppm, Range: 500 ppm, High: 200 ppm, Low: 35 ppm, STEL: 100 ppm, TWA: 35 ppm, Span: 50 ppm). Below these is a table with tabs for 'Alarm' and 'Bump/Calibration'. The 'Bump/Calibration' tab is active, showing a table with 6 rows of data. At the bottom, there are buttons for Search, Read, Write, Load, Save, Firmware Upgrade, and About.

No	Type	Result	Gas Applied	Event Time
1	Bump	passed	26ppm	09/25/2019 15:43:19
2	Calibration	passed	50ppm	09/25/2019 15:33:34
3	Calibration	passed	0ppm	09/25/2019 15:32:49
4	Calibration	passed	0ppm	09/25/2019 15:31:10
5	Calibration	failed	50ppm	09/25/2019 15:27:40
6	Calibration	passed	0ppm	09/25/2019 15:26:55

Bump/Calibration Results Recalled from UNI Instrument

6. UNI Docking Box (MP100T) Calibrations

6.1 Docking Box Set-up

Before the Docking Box can be used for calibrations, it must be set up for the desired gas type and span concentration.

1. Connect the USB cable to both the Docking Box and the PC.

⚠WARNING! Connect only in non-hazardous environments!

2. Start mPower Suite on the PC and click the “Search” button on the bottom panel.
3. Find the Docking Box in the left panel Device Connected list and click on it to get the Docking Box configuration page.
4. Select the Gas Name from the pull-down menu and edit the cylinder gas concentration, lot number and expiration date. For multiple gases, right click on the gas name field and select “Add gas” or “Delete gas”. During calibration or bump, the Docking Box will select the gas corresponding to the type of UNI in the cradle. Be sure the cylinder gas matches the UNI type.

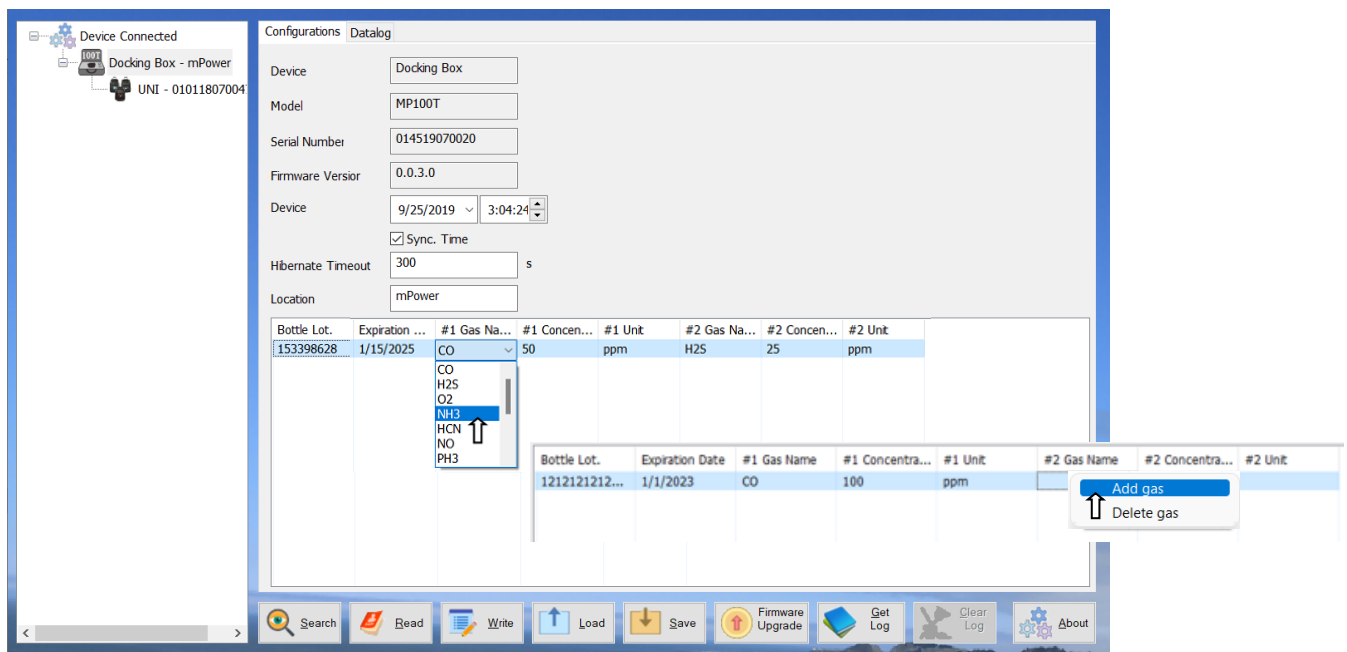

5. Click “Write” to upload the configuration to the Docking Box. As a reminder, attach a label to the front panel indicating the gas type. Labels for CO and H₂S are provided.
6. Calibrations or bump tests will not be allowed after the cylinder expiration date entered.
7. Hibernate Timeout is the number of seconds of inaction before the Docking Box turns itself off automatically. Press the Cal/ button to turn back on.
8. “Save” stores the current Docking Box configuration file to the PC.
9. “Load” calls up a stored Docking Box configuration file from the PC to mPower Suite.
10. To update the Docking Box firmware, select “Firmware Upgrade”. The MP100T firmware must first be downloaded to the PC from the mPower website www.mPowerinc.com.

6.2 Docking Box Gas Connection and Calibration Process

1. Connect gas and regulator to the quick-connect in the Cal gas inlet port of the Docking Box using 6-mm or ¼-inch o.d. tubing
2. If ambient air is not free of detectable compounds, connect the air inlet to a fresh air source.
3. If desired, connect tubing to the gas outlet to exhaust away from the operator breathing area.



1. **USB Port**
2. **Monitor cradle**
3. **Unit LED**
4. **Status LED**
5. **Cal button**
(Calibrates sensor)
6. **Bump button**
(Briefly applies gas to test sensor function)
7. **Air inlet**
8. **Cal gas inlet**
9. **Gas Outlet**

4. Place the UNI instrument face-down into the cradle.
5. If the Status LED [4] is off, press Cal/⏻ [5] until the LED turns green.
6. Push Cal [5] to initiate calibration or Bump [6] to run a bump test. The LED should blink green for about 100 s during calibration or 25 s during a bump test.
7. If the calibration or bump is successful, the Unit LED [3] will be green, otherwise red.
8. Up to 2000 Cal or Bump reports will be saved in the internal storage of the Docking Box.
9. To power off, hold the Cal button until the status LED turns off.

Summary of Visual and Audio Alarm Indications

LED	Color	Buzzer	Description
Unit LED [3]	Green blinking	None	Cal/bump testing
	Green	Beep Once	Cal/bump test pass
	Orange	None	Sensor type mismatch
	Red	3 beeps per sec	Cal/bump test fail
Status LED [4]	Green	None	Power On
	Green blinking	None	Low battery
	Orange	None	Charging
	Red blinking	None	Pump block

6.3 Docking Box Data Download and Calibration Certificates

1. To download Cal/Bump test reports, click the Download Log button on the bottom panel. It is not necessary to have a UNI in the Docking Box. View the reports under the Datalog tab.

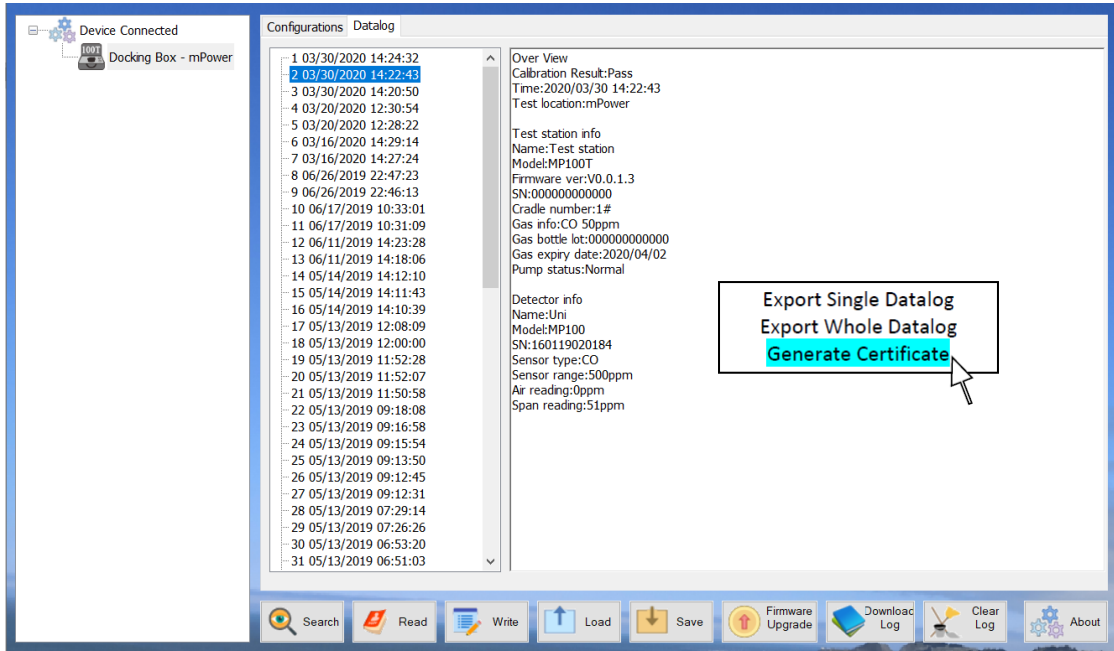

Bump/Calibration Results Recalled from UNI Docking Box

2. To export data to a csv file readable by Excel or other spreadsheet software, move the cursor over the right data panel and click the right mouse button, and then select either the current Cal/Bump result (Single Datalog) or all the stored results (Whole Datalog).
3. To print a Calibration Certificate, right-click the mouse in the right panel and select Generate Certificate. Enter any desired information such as operator name and cylinder lot number, and click Print at the bottom.

UNI MP100 User's Guide

Certificate Management

×



CERTIFICATE OF MONITOR CALIBRATION

DATE

CALIBRATED BY

APPROVED BY

SIGNATURE (with date)

ASSET ID #

TITLE

TITLE

CALIBRATION RESULT

INSTRUMENT INFORMATION

Brand

Serial #

Model #

Sensor Type	Gas	Concentration	Post Cal Reading	Sensor Serial #
CO	CO	50ppm	Pass	

<p>Calibration Gas <input type="text"/></p> <p>Expiration Date <input type="text" value="4/2/2020"/></p> <p>Lot # <input type="text" value="000000000000"/></p> <p>Manufacturer <input type="text"/></p>	<p>Monitor Kit Complete <input type="text"/></p> <p>Missing Parts <input type="text"/></p>
--	--

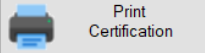

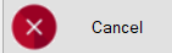

7. Maintenance and Specifications

⚠ CAUTION!

Maintenance should be performed only by a qualified person who has proper training and fully understands the contents of the manual.

7.1 Battery Replacement

The battery typically lasts 3 years, but may be drained faster if the unit has frequently gone into alarm. When the charge is low, the unit displays a red battery icon and a battery low alarm is triggered once per minute. When the

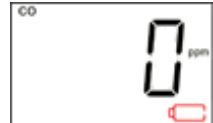

battery is dead, **BAT LOW** is displayed and the battery dead alarm triggers every second. The battery needs to be replaced, as follows:

- 1) Turn off the MP100 and place it face down on a soft surface.
- 2) Use a T10 Torx screwdriver to loosen each of the four screws by turning them counterclockwise.
- 3) Remove the top cover after carefully unplugging the buzzer connector.
- 4) Slide the battery out of its compartment.
- 5) Place the new battery into the compartment with its “+” end oriented toward the “+” on the printed circuit board.
- 6) Plug in the buzzer connector and reinstall the top cover.
- 7) Re-install the screws through the back cover. Be careful to not overtighten the screws.

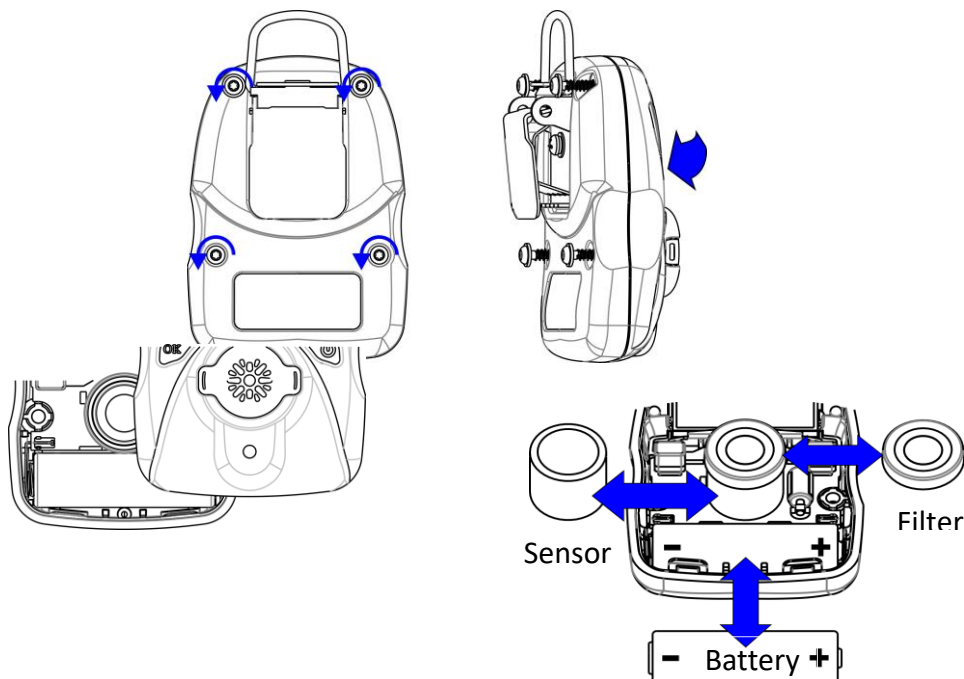

UNI MP100 User's Guide

⚠ WARNING !

- Never operate the monitor when the cover is removed.
- Remove the monitor cover and battery only in area known as non-hazardous.
- Use only mPower's lithium battery part number M500-0001-000 [1.17.02.0002] (3.6V, 2700mAh, AA size) or part No. ER14505 cell manufactured by EVE Energy Co., LTD.

⚠ AVERTISSEMENT !

- N'utilisez jamais le moniteur lorsque le couvercle est enlevé.
- Retirer le couvercle du moniteur et la batterie uniquement dans une zone connue comme non dangereuse.
- Utilisez uniquement la batterie au lithium de mPower, pièce No. M500-0001-000 [1.17.02.0002] (3.6V, 2700mAh, taille AA) ou celle de EVE Énergie Cie., Lté, pièce No. ER14505.

7.2 Sensor Filter Replacement

A “peel-and-stick” filter should be used on the MP100 in order to keep debris from fouling the sensor. Replace the filter whenever it appears dirty, is clogged with particles, has contacted liquid, or when sensor response becomes weak and/or slow. Use external clip-on filters when operating in dusty environments for easier filter exchange (but note that these may cause slower response).

- 1) Turn off the MP100 and remove the top cover as described above for battery replacement.
- 2) Peel off the old filter, and gently press a new filter onto the sensor.
- 3) Reconnect the buzzer and reinstall the top cover as described above for battery replacement. Be careful to not overtighten the screws.



External Filter Clip

7.3 Sensor Replacement

MP100 models are designed for easy sensor replacement. CO and H₂S sensors have typical operating lives of 5 years, while others are 1 to 2 years, as per warranty (See Specifications in Section 7.8).

- 1) Turn off the MP100 and remove the top cover as described above for battery replacement.
- 2) Replace the old sensor with a new one. Make sure the pins are not bent or corroded. Align the pins to the corresponding holes and push the sensor straight in. The sensor should fit flush against the printed circuit board.
- 3) Check the instrument filter and, if needed, replace as described in the previous section.
- 4) Reconnect the buzzer and reinstall the top cover as described above for battery replacement. Be careful to not overtighten the screws.

⚠ CAUTION!







Sensors are not interchangeable. Use only mPower sensors, and use only the sensor type specified for your MP100 monitor. Use of non-mPower components will void the warranty and can compromise the safe performance of this product.

UNI MP100 User's Guide







7.4 Troubleshooting

Problem	Possible Reason	Solution
Cannot turn on unit	Battery not installed	Install battery.
	Depleted or defective battery.	Replace battery.
Unit shows “Cal Due” or “Bump Due” and shuts off after 30 seconds	Calibration or bump due date passed	Press Left key to prevent shut off. Access program menu and perform bump or calibration. Or use mPower Suite to update to later Cal or Bump Due date. If battery has been replaced, re-set clock in Suite before calibration.
Reading abnormally low (or Fails Calibration)	Incorrect calibration or zeroed when detectable gas is present.	Zero and Span calibrate. Ensure clean air when zeroing.
	Calibration gas flow > 0.6 LPM	Use flow between 0.3 and 0.6 LPM
	On-board filter plugged.	Replace filter. Use external filter clip in dusty environments.
	Weak sensor.	Have Service Technician check raw counts and replace sensor as needed.
	Calibration Adapter is attached.	Remove Calibration Adapter.
Reading abnormally high (or Fails Calibration)	Incorrect calibration or degraded span gas used or tubing absorbs span gas	Zero and Span calibrate instrument. Ensure span gas is not expired. Used short, inert (PTFE) tubing
	Calibration gas flow < 0.3 LPM	Use flow between 0.3 and 0.6 LPM
	Environment contains cross-sensitive substances	Check TA Note 4 for possible cross-sensitivities.
Reading abnormally noisy (or Fails Calibration)	Incorrect calibration or degraded span gas used or tubing absorbs span gas	Zero and Span calibrate instrument. Ensure span gas is not expired. Used short, inert (PTFE) tubing
	Weak sensor.	Have Service Technician check raw counts and replace sensor as needed.
Buzzer, LED, or vibration alarm inoperative	Bad buzzer, LEDs, or vibration alarm.	Call authorized service center.
	Blocked alarm port	Unblock alarm port.

7.5 Alarm Signal Summary

Display	Reason
	<p>Over Range alarm: Buzzer 3 beeps per second LED 3 flashes per second 1 Vibration per second “OVER” and “500” (“sensor range”) 1 flash per second</p>
	<p>High alarm: Buzzer 3 beeps per second LED 3 flashes per second 1 Vibration per second “HIGH” 2 flashes per second</p>
	<p>Low alarm: Buzzer 2 beeps per second LED 2 flashes per second 1 Vibration per second “LOW” 2 flashes per second</p>
	<p>STEL alarm: Buzzer 1 beeps per second LED 1 flash per second 1 Vibration per second “STEL” 2 flashes per second</p>
	<p>TWA alarm: Buzzer 1 beep per second LED 1 flash per second 1 Vibration per second “TWA” 2 flashes per second</p>
	<p>Negative Drift alarm : Buzzer 1 beep per second LED 1 flash per second 1 Vibration per second</p>

UNI MP100 User's Guide

	<p>Bump Overdue alarm: Buzzer 1 beep per minute LED 1 flash per minute 1 Vibration per minute</p>
	<p>Cal Overdue alarm: Buzzer 1 beep per minute LED 1 flash per minute 1 Vibration per minute</p>
	<p>Battery Low alarm: Buzzer 1 beep per second LED 1 flash per second “bAT LoW”1 flash per second</p>
	<p>Battery Empty alarm: Buzzer 1 beep per minute LED 1 flash per minute 1 Vibration per minute  1 flash per minute</p>
	<p>Sensor Error alarm: Buzzer 1 beep per second LED 1 flash per second “SEN Err”1 flash per second</p>

7.6 Sensor Specifications and Default Configurations

Sensor	Range (ppm)	Resolution (ppm)	Span* (ppm)	Low (ppm)	High (ppm)	STEL (ppm)	TWA (ppm)	Panel Ring	Response Time t ₉₀ (s)	Calibration Interval [†]
CO	0-500	1	100	35	200	100	35	Red	15	3 mo
	0-1000	1	100	35	200	100	35		15	3 mo
	0-1999	1	100	35	200	100	35		15	3 mo
H ₂ S	0-50	0.1	25	10	20	15	10	Blue	15	3 mo
	0-100	0.1	25	10	20	15	10		15	3 mo
	0-200	0.1	25	10	20	15	10		15	3 mo
	0-1000	1	25	10	20	15	10		30	3 mo
NH ₃	0-100	1	50	25	50	35	25	Yellow	150	1 mo
	0-500	1	50	25	50	35	25		150	1 mo
Cl ₂	0-50	0.1	10	2	5	1	0.5	Yellow	30	1 mo
ClO ₂	0-1	0.01	0.5**	0.2	0.5	0.3	0.1	Yellow	120	1 mo
COCl ₂	0-1	0.01	0.5**	0.2	0.5	0.3	0.1	Yellow	120	1 mo
H ₂	0-1000	1	100	100	400	400	100	Yellow	70	1 mo
	0-2000	1	100	100	400	400	100		70	1 mo
HCN	0-100	0.1	10	4.7	5	4.7	4.7	Yellow	200	3 mo
NO	0-250	1	25	25	50	25	25	Yellow	30	1 mo
NO ₂	0-20	0.1	5	1	10	1	1	Yellow	30	1 mo
PH ₃	0-20	0.01	5	1	2	1	0.3	Yellow	60	1 mo
SO ₂	0-20	0.1	5	2	10	5	2	Yellow	15	3 mo
ETO (Ethylene Ox)	0-100	0.1	10	2	5	2	1	Yellow	120	1 mo
	0-200	0.1	10	2	5	2	1		120	1 mo
O ₃	0-5	0.01	0.5**	0.2	0.3	0.1	0.1	Yellow	60	1 mo
HF	0-20	0.1	6**	2	6	6	3	Yellow	90	1 mo
HCl	0-15	0.1	10**	2	5	5	1	Yellow	90	1 mo
CH ₃ SH	0-10	0.1	5	2	5	2	0.5	Yellow	20	3 mo
Acetaldehyde	0-20	0.1	5	2	5	2	1	Yellow	120	1 mo
THT	0-40	0.1	10	5	10	5	5	Yellow	60	1 mo
AsH ₃	0-1	0.01	0.8**	0.2	0.5	0.3	0.1	Yellow	30	1 mo

* The default span setting equals the recommended span gas concentration.

** Calibration of these sensors requires a gas generator or other special precautions. See TA Note 6 for recommended procedures and gas sources.



† Suggested calibration interval. Actual required interval must be defined by user and may be shorter under harsh conditions or longer under favorable conditions – see TA Note 3 for details.

Sensor	Range (%)	Resolution (%)	Span*	Low [†] (%)	High [†] (%)	STEL (%)	TWA (%)	Panel Ring	Response Time t ₉₀ (s)
O ₂ (Galvanic or Lead-Free)	0 - 25	0.1	0.0	19.5	23.5	-	-	Dark	15
	0 - 30	0.1	0.0	19.5	23.5	-	-	Blue	15
O ₂ Inert Alarms [†]	0 - 30	0.1	0.0	4.0	5.0	-	-		15

* Oxygen sensors in MP100 use pure nitrogen or other inert gas for both Span and Bump Test.

† Standard O₂ alarms are triggered when O₂ levels go either below the Low Alarm or above the High alarm. Inert monitor alarms are off below the Low alarm or above 19.5% and on above Low & High alarms but below 19.5%.

7.7 Instrument Specifications

Size	3.46 x 2.44 x 1.3 in (88 x 62 x 33 mm)
Weight	4.4 oz (125 g)
Sensors	Electrochemical
Response time (t90)	15 seconds (CO/H ₂ S/O ₂) Others vary, see individual sensor specification sheet or TA Note 4
Battery	Replaceable AA size Lithium battery, 3 years typical operation
Temperature	-4°F to 122°F (-20°C to 50°C)
Humidity	5 to 95% relative humidity (non-condensing)
Alarm Type	<ul style="list-style-type: none"> • High, Low, STEL & TWA alarms adjustable • Over range alarm • Low battery alarm
Alarm Signal	<ul style="list-style-type: none"> • 95 dB @ 30 cm • Bright red LEDs • Built in vibrator
Calibration	2-point calibration, zero and span, power on zero (user-selectable)
Event Log	Up to 50 alarm events
IP Rating	IP-67
EMI/RFI	EMC directive: 2014/30/EU
Safety Certifications	 Class I, Div 1, Group ABCD Class II, Div 1, Group EFG Class III, Div 1 T4, -20°C ≤ T _{amb} ≤ +50°C IECEX Ex ia IIC T4 Ga ATEX  II 1G Ex ia IIC T4 Ga
Sensor Life	CO & H ₂ S expected operating life 5 years or longer, others 1 to 2 years as per warranty
Warranty	2 years on O ₂ , CO, H ₂ S, SO ₂ , HCN, NO, NO ₂ , and PH ₃ units including sensor; 1 year on others

Technical Support and mPower Contacts

mPower Electronics Inc.

3046 Scott Blvd. Santa Clara, CA 95054

Phone: (408) 320-1266

Fax: (669) 342-7077

info@mpowerinc.com

www.mpowerinc.com

