

GasAlert **Quattro**

1, 2, 3, and 4-Gas Detector

GASTECH
AUSTRALIA

Operator's Manual

BW
Technologies
by Honeywell

Table of Contents

Limited Warranty and Limitation Liability

Contacting BW Technologies by Honeywell

Introduction	1
Zeroing the Sensors	1
Safety Information - Read First	1
Parts of the GasAlertQuattro	4
Screen Elements	5
Pushbutton	6
Sensor Poisons and Contaminants	7
Connecting the Gas Cylinder to the Detector	8
Calibration	9
Bump Test	12
Alarms	13
User Options and Sensor Configuration	16
Maintenance	19
WEEE Directive and Battery Directive	23
Removal and Disposal of the Coin Cell	24
Specifications	27
ATEX Performance Approval	30
Troubleshooting	33
Replacement Parts and Accessories	41

Limited Warranty and Limitation Liability

BW Technologies LP (BW) warrants the product to be free from defects in material and workmanship under normal use and service for a period of two years, beginning on the date of shipment to the buyer. This warranty extends only to the sale of new and unused products to the original buyer. BW's warranty obligation is limited, at BW's option, to refund of the purchase price, repair or replacement of a defective product that is returned to a BW authorized service center within the warranty period. In no event shall BW's liability hereunder exceed the purchase price actually paid by the buyer for the Product.

This warranty does not include:

- a) fuses, disposable batteries or the routine replacement of parts due to the normal wear and tear of the product arising from use;
- b) any product which in BW's opinion, has been misused, altered, neglected or damaged, by accident or abnormal conditions of operation, handling or use;
- c) any damage or defects attributable to repair of the product by any person other than an authorized dealer, or the installation of unapproved parts on the product; or

The obligations set forth in this warranty are conditional on:

- a) proper storage, installation, calibration, use, maintenance and compliance with the product manual instructions and any other applicable recommendations of BW;
- b) the buyer promptly notifying BW of any defect and, if required, promptly making the product available for correction. No goods shall be returned to BW until receipt by the buyer of shipping instructions from BW; and
- c) the right of BW to require that the buyer provide proof of purchase such as the original invoice, bill of sale or packing slip to establish that the product is within the warranty period.

THE BUYER AGREES THAT THIS WARRANTY IS THE BUYER'S SOLE AND EXCLUSIVE REMEDY AND IS IN LIEU OF ALL OTHER WARRANTIES, EXPRESS OR IMPLIED, INCLUDING BUT NOT LIMITED TO ANY IMPLIED WARRANTY OF MERCHANTABILITY OR FITNESS FOR A PARTICULAR PURPOSE. BW SHALL NOT BE LIABLE FOR ANY SPECIAL, INDIRECT, INCIDENTAL OR CONSEQUENTIAL DAMAGES OR LOSSES, INCLUDING LOSS OF DATA, WHETHER ARISING FROM BREACH OF WARRANTY OR BASED ON CONTRACT, TORT OR RELIANCE OR ANY OTHER THEORY.

Since some countries or states do not allow limitation of the term of an implied warranty, or exclusion or limitation of incidental or consequential damages, the limitations and exclusions of this warranty may not apply to every buyer. If any provision of this warranty is held invalid or unenforceable by a court of competent jurisdiction, such holding will not affect the validity or enforceability of any other provision.

Contacting BW Technologies by Honeywell

USA: 1-888-749-8878

Canada: 1-800-663-4164

Europe: +44(0) 1295 700300

Other countries: +1-403-248-9226

Email us at: info@gasmonitors.com

Visit BW Technologies by Honeywell's website at: www.gasmonitors.com

Introduction

The operator's manual provides basic information to operate the GasAlertQuattro gas detector. For complete operating instructions, refer to the *GasAlertQuattro Technical Reference Guide* provided on the CD-ROM. The GasAlertQuattro gas detector ("the detector") is designed to warn of hazardous gas levels above user-defined alarm setpoints.

The detector is a personal safety device. It is your responsibility to respond properly to the alarm.

Note

The detector is shipped with English as the default displayed language. Additional languages provided are French, German, Portuguese, and Spanish. The screens for the additional languages are displayed on the detector and in the corresponding operator's manual.

Zeroing the Sensors

To zero the sensors, refer to steps #1-3 in **Calibration** on page 9.

GasAlertQuattro

Safety Information - Read First

Use the detector only as specified in this operator's manual and the technical reference guide, otherwise protection provided by the detector may be impaired. Read the following **Cautions** before using the detector.

⚠ Cautions

- **Warning:** Substitution of components may impair Intrinsic Safety.
- **Before using the detector, refer to *Sensor Poisons and Contaminants*.**
- **Protect the combustible sensor from exposure to lead compounds, silicones, and chlorinated hydrocarbons. Although certain organic vapors (such as leaded gasoline and halogenated hydrocarbons) may temporarily inhibit sensor performance, in most cases the sensor will recover after calibration.**
- **Caution:** For safety reasons, this equipment must be operated and serviced by qualified personnel only. Read and understand the technical reference guide completely before operating or servicing.

- If using the detector near its upper or lower operating temperature, BW Technologies by Honeywell recommends zeroing or activating the detector in that environment.
 - Charge the detector before first-time use. BW Technologies by Honeywell recommends the detector be charged after every workday.
 - Calibrate the detector before first-time use and then on a regular schedule, depending on use and sensor exposure to poisons and contaminants. BW recommends that the sensors must be calibrated regularly and at least once every 180 days (6 months).
 - Calibrate only in a safe area that is free of hazardous gas in an atmosphere of 20.9% oxygen.
 - The combustible sensor is factory calibrated to 50% LEL methane. If monitoring a different combustible gas in the % LEL range, calibrate the sensor using the appropriate gas.
 - Only the combustible gas detection portion of this instrument has been assessed for performance by CSA International.
 - BW recommends that the combustible sensor be checked with a known concentration of calibration gas after any exposure to contaminants/poisons such as sulfur compounds, silicon vapors, halogenated compounds, etc.
 - BW recommends to bump test the sensors before each day's use to confirm their ability to respond to gas by exposing the detector to a gas concentration that exceeds the alarm setpoints. Manually verify that the audible, visual, and vibrator alarms are activated. Calibrate if the readings are not within the specified limits.
 - For an additional bump test caution relating to the ATEX performance certification, refer to *Bump Test* on page 12.
 - Caution: High off-scale LEL readings may indicate an explosive concentration.
 - Any rapid upscaling reading followed by a declining or erratic reading may indicate a gas concentration beyond upper scale limit, which can be hazardous.
 - For use only in potentially explosive atmospheres where oxygen concentrations do not exceed 20.9% (v/v). Oxygen deficient atmospheres (<10% v/v) may suppress some sensor outputs.
 - Extended exposure of the GasAlertQuattro to certain concentrations of combustible gases and air may stress the detector element that can seriously affect its performance. If an alarm occurs due to a high concentration of combustible gases, a calibration should be performed, or if needed, the sensor replaced.
 - Before using common products around sensors, refer to *Sensor Poisons and Contaminants* on page 7.
 - High concentrations of certain toxic gases, for example H₂S, may have an adverse effect on the LEL sensor. This effect, known as inhibition, is usually temporary but in extreme circumstances can impair the sensitivity of the LEL sensor.
- After any gas exposure that causes an alarm in the toxic gas sensors, the LEL sensor should be verified with a bump test, and recalibrated if necessary.





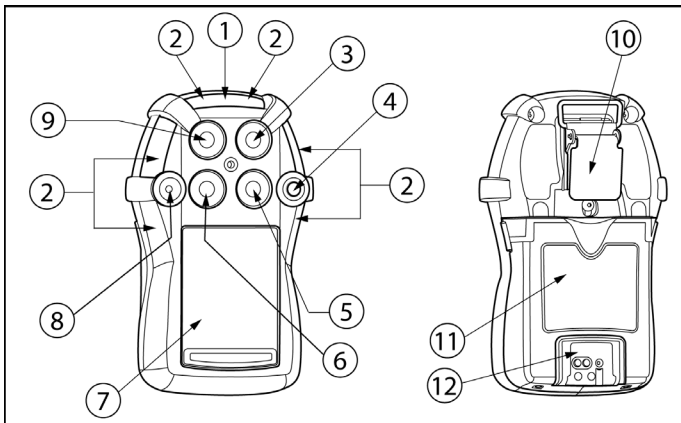



















- **Warning:** The lithium battery (QT-BAT-R01) may present a risk of fire or chemical burn hazard if misused. Do not disassemble, heat above 212°F (100°C), or incinerate.
- **Warning:** Do not use any other lithium batteries with the GasAlertQuattro detector. Use of any other cell can cause fire and/or explosion. To order and replace the QT-BAT-R01 lithium battery, contact BW Technologies by Honeywell.
- **Warning:** Lithium polymer cells exposed to heat at 266°F (130°C) for 10 minutes can cause fire and/or explosion.
-  **Warning:** This instrument contains a lithium polymer battery. Dispose of used lithium cells immediately. Do not disassemble and do not dispose of in fire. Do not mix with the solid waste stream. Spent batteries must be disposed of by a qualified recycler or hazardous materials handler.
- Keep lithium cells away from children.
- Deactivating the detector by removing the battery pack may cause improper operation and harm the detector.

Parts of the GasAlertQuattro

















Item	Description	Item	Description	Item	Description	Item	Description
1	IntelliFlash (green LED)	4	Pushbutton	7	Liquid crystal display (LCD)	10	Alligator clip
2	Visual alarm indicator (red LED)	5	Combustible (LEL) sensor	8	Audible alarm	11	Battery pack
3	Hydrogen sulfide (H ₂ S) sensor	6	Carbon monoxide (CO) sensor	9	Oxygen (O ₂) sensor	12	Charging connector and IR interface

Screen Elements

	Calibration gas cylinder		Display during startup to indicate audio and visual alarm pass or fail during a MicroDock II bump test		Displays if calibration is initiated and the Cal IR Lock option is enabled
	Bump test gas cylinder		Displays when the Stealth option is enabled		Displays during calibration and when startup is complete
	Indicates pass for startup, sensors, calibrations, and bump tests		Displays when the detector is in alarm (not applicable to TWA and STEL)		Battery — full charge
	Indicates fail for startup, sensors, calibrations, and bump tests		Displays when there is a warning, failure, error, or low battery		Battery — half charge
	Pushbutton displays when screen provides an option to end or skip		Heartbeat pulses continually during normal operation to verify the detector is operating correctly		Low battery warning
20.9 O ₂ %	Reading displays with white background during normal operation		Displays for STEL alarms and setpoints		Displays when the detector is connected to an IR Link
19.5 O ₂ %	Reading displays with alternating black background when the sensor is in alarm		Displays for TWA alarms and setpoints		Displays when the detector is communicating with Fleet Manager II
	Grey check box displays during bump tests or calibration when a gas is not due		Displays during peak gas exposure information screens		Displays when the detector's firmware is being updated
	Displays when the most recent calibration or bump test failed but a previous calibration or bump test is still valid within the due date. Also displays during auto-zero.		Displays during an operation such as auto-zeroing		Displays when gas should no longer be applied after a bump test or calibration

Pushbutton

Pushbutton	Description
	<ul style="list-style-type: none">• To activate the detector, press and hold  in a safe area that is free of hazardous gas and in an atmosphere of 20.9% oxygen.• To deactivate the detector, press and hold  during the powering off countdown. Release  when OFF displays.• To view the date/time, current battery power, calibration due date, bump test due date, TWA, STEL, and peak readings, press  twice rapidly. To clear the TWA, STEL, and peak readings, press and hold  when the LCD displays Hold  to reset peaks, TWA, STEL.• To initiate calibration, press and hold  while the detector performs the OFF countdown. Continue holding  while the LCD briefly deactivates and then reactivates to begin the calibration countdown. Release  when Calibration started displays.• To activate the backlight, press  and release.• To acknowledge latching alarms, press .• To acknowledge a low alarm and disable the audible alarm, press . The Low Alarm Acknowledge option must be enabled in Fleet Manager II.• To acknowledge any of the “due today” messages (calibration and bump test) press . If enabled, the force calibration and force bump features cannot be bypassed.

Sensor Poisons and Contaminants

Several cleaners, solvents, and lubricants can contaminate and cause permanent damage to sensors. Before using cleaners, solvents, and lubricants in close proximity to the detector sensors, read the following caution and table.

⚠ Caution

Use only the following BW Technologies by Honeywell recommended products and procedures:

- Use water based cleaners.
- Use non-alcohol based cleaners.
- Clean the exterior with a soft, damp cloth.
- Do not use soaps, polishes, or solvents.

The following table lists common products to avoid using around sensors.

Cleaners and Lubricants	Silicones	Aerosols
Brake cleaners	Silicone cleaners and protectants	Bug repellents and sprays
Lubricants	Silicone based adhesives, sealants, and gels	Lubricants
Rust inhibitors	Hand/body and medicinal creams that contain silicone	Rust inhibitors
Window and glass cleaners	Tissues containing silicone	Window cleaners
Dishsoaps	Mold releasing agents	
Citrus based cleaners	Polishes	
Alcohol based cleaners		
Hand sanitizer		
Anionic detergents		
Methanol (fuels and antifreezes)		

Connecting the Gas Cylinder to the Detector

Gas Cylinder Guidelines

- To ensure accurate calibration, use a premium-grade calibration gas. Use gases approved by the National Institute of Standards and Technology.
- If a certified calibration is required, contact BW Technologies by Honeywell.
- Do not use a gas cylinder past its expiration date.

Gas Cylinder Connection

Read the following steps (1-5) prior to initiating calibration.

1. Verify the calibration gas being used matches the span concentration value(s) that are set for the detector.
2. Connect the calibration hose to the 0.5 l/min regulator on the gas cylinder. For use with the MicroDock II, use a demand flow regulator and refer to the *MicroDock II User Manual*.
3. Connect the calibration hose to the intake inlet on the calibration cap. Arrows on the calibration cap indicate the direction of gas flow.
4. Begin the calibration procedures. Do not attach the calibration cap until instructed to apply gas. When instructed, place the calibration cap on the detector and tighten the knob.
NOTE: Ensure the cap is securely fastened before applying gas.
5. When calibration is complete, disconnect the hose from the calibration cap and the regulator. Remove the calibration cap from the detector.

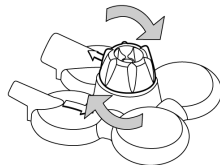

Note

Only use the calibration cap during the calibration process.

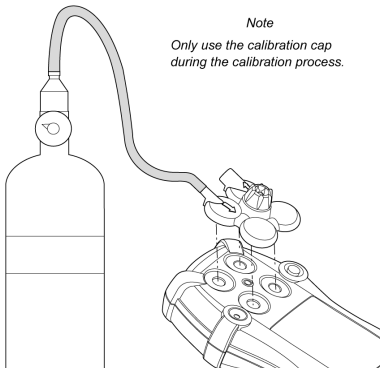

Calibration

Calibration is performed to adjust the sensitivity levels of sensors to ensure accurate responses to gas.

This calibration procedure is written as the procedure is intended. If an error or alarm screen displays, refer to *Calibration Troubleshooting* in the GasAlertQuattro Technical Reference Guide.

⚠ Caution

Calibrate only in a safe area that is free of hazardous gas in an atmosphere of 20.9% oxygen.

If performing single gas calibration, calibrate O₂ first.

Note

The maximum hose length for calibration is 3 ft. (1 m).

The following steps are written for use with a standard quad gas cylinder.

*Calibration can only be aborted after the sensors have been zeroed. If  is pressed to abort, **CALIBRATION cancelled displays**.*

1. Press and hold  as the detector performs the **Powering off** countdown.



Continue holding  when **OFF** displays and the detector briefly deactivates.

2. The detector activates again and performs the calibration countdown. Continue holding until **Starting Calibration** displays.

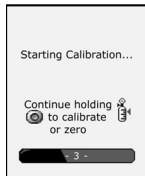
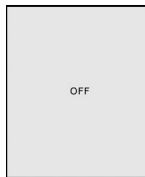

3. The detector enters the zero function. **zeroing** displays while the detector zeros all of the sensors.

⚠ Caution

If a sensor fails to zero, it cannot be calibrated. Refer to *Startup Self-Test Troubleshooting* in the GasAlertQuattro Technical Reference Guide.

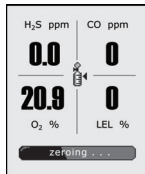

If the **IR Lock** option is enabled, the following screen displays to indicate calibration can only be performed using an IR device (MicroDock II or IR Link).

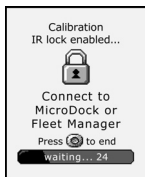

4. When the following screen displays, attach the calibration cap and apply calibration gas at a flow rate of 250-500 ml/min. Refer to **Connecting the Gas Cylinder to the Detector**.

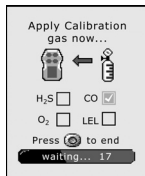

If a sensor is not yet due for calibration, its box will have a greyed out checkmark.

5. The detector initially tests for gas. When a sufficient amount of gas is detected,  displays beside each gas that is detected.



6. The detector then begins calibrating the sensors. The following activities occur during the span:

- **calibrating** displays at the bottom of the screen.
- Gas values adjust during the span.
- Target gas values that are defined in Fleet Manager II display above or below the adjusting gas value.

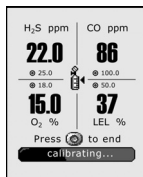

To abort calibration after the sensors have been zeroed, press .

7. When the following screen displays, close the valve on the gas cylinder and remove the calibration cap from the detector.

A check mark displays beside each sensor that has calibrated successfully.

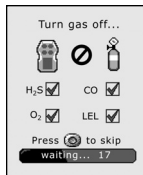

8. When calibration is complete, the following screen displays.

Note

The calibration due date cannot be reset for a sensor that fails calibration. If a sensor fails or an error screen displays, refer to Calibration Troubleshooting in the GasAlertQuattro Technical Reference Guide.

9. All successfully calibrated sensors automatically reset to the number of days defined in the **Cal Interval** field in Fleet Manager II.

The calibration due dates can be changed in Fleet Manager II.

10. The detector now enters normal operation.

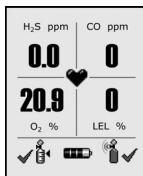
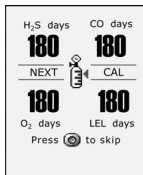
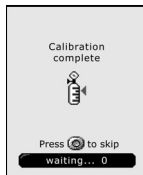

Bump Test

A bump test applies test gas to force the detector into alarm. A bump test should be performed regularly to confirm the sensors are responding correctly to gas, and that the audible, visual and vibrator alarms activate during an alarm condition.

The detector can also prompt for a bump test during startup when the Bump Test Interval is defined. Refer to the GasAlert-Quattro Technical Reference Guide.

⚠ Caution

BW recommends to bump test the sensors before each day's use to confirm their ability to respond to gas by exposing the sensors to a gas concentration that exceeds alarm setpoints.

To operate the detector in accordance with ATEX performance certification requirements, the user must complete a bump test before each day's use.

(Per EN 60079-29-1 and EN 60079-29-2.)

1. Connect the calibration hose to the 0.5 l/min regulator on the gas cylinder. Refer to **Connecting the Gas Cylinder to the Detector**.

To bump test using the MicroDock II station, refer to the MicroDock II User Manual.

2. Connect the calibration hose to the intake inlet on the calibration cap. Arrows on the calibration cap indicate the direction of gas flow.

3. Attach and tighten the calibration cap onto the detector and apply gas. Verify the visual, audible, and vibrator alarms activate.
4. Close the regulator and remove the calibration cap. The detector temporarily remains in alarm until the gas clears from the sensors.

Note

In normal operating mode, it is possible to display measured values with calibration gas applied to determine any measurement errors.

Alarms



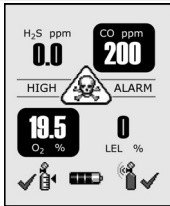
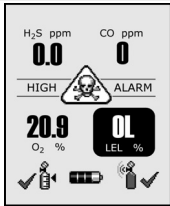
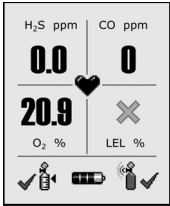
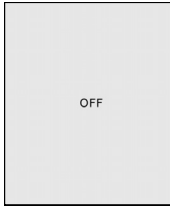

Refer to the following table for information about alarms and corresponding screens. For more information about alarms refer to the GasAlertQuattro Technical Reference Guide.

Alarm	Screen	Alarm	Screen
<p>Low Alarm</p> <ul style="list-style-type: none"> • Slow siren (upward tone) • Slow flash • Black box around gas flashes • Vibrator alarm activates 		<p>TWA Alarm</p> <ul style="list-style-type: none"> • Fast siren (downward tone) • Fast flash • Black box around gas flashes • Vibrator alarm activates 	
<p>High Alarm</p> <ul style="list-style-type: none"> • Fast siren (downward tone) • Fast flash • Black box around gas flashes • Vibrator alarm activates 		<p>STEL Alarm</p> <ul style="list-style-type: none"> • Fast siren (downward tone) • Fast flash • Black box around gas flashes • Vibrator alarm activates 	

Alarm	Screen	Alarm	Screen
<p>Multi Alarm</p> <ul style="list-style-type: none"> • Alternating low and high alarm siren and flash • Black box around gas flashes • Type of alarm alternates • Vibrator alarm activates 		<p>Over Limit (OL) Alarm</p> <ul style="list-style-type: none"> • Fast siren (downward tone) • Fast flash • Black box around gas flashes • Vibrator alarm activates <p><i>Note: LCD may also display an under limit reading (-OL)</i></p>	
<p>Sensor Failure Alarm</p> <ul style="list-style-type: none"> • ✕ displays 		<p>Normal Deactivation</p> <ul style="list-style-type: none"> • Sequence of alternating beeps and alternating flashes • Vibrator alarm activates • Countdown initiates • OFF displays 	

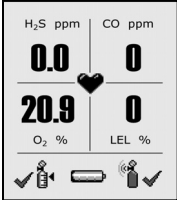
Note

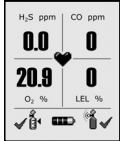
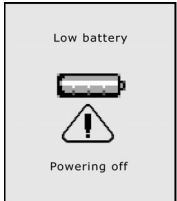
If enabled, during an alarm condition the **Latching Alarms** option causes the low and high gas alarms (audible, visual, and vibrator) to persist until the alarm is acknowledged by pressing  and the gas concentration is below the low alarm setpoint. The peak concentration values display continually until the alarm no longer exists. Enable/disable **Latching Alarms** in Fleet Manager II. Local regulations may require the **Latching Alarms** option be enabled. The Latching Alarms option must be enabled if the detector is to be used in accordance with ATEX gas performance certification requirements (BAM).

Alarm	Screen	Alarm	Screen
<p>Low Battery Alarm</p> <ul style="list-style-type: none"> Sequence of 10 rapid sirens and alternating flashes with 7 seconds of silence in between (continues for 15 minutes)  flashes Vibrator alarm pulses After 15 minutes of the low battery alarm sequence, the detector enters critical battery alarm (see Critical Battery Alarm below) 		<p>Confidence/compliance Beep</p> <ul style="list-style-type: none"> One beep every 1-120 seconds (beep frequency is defined with Confidence/compliance Beep Interval option) <p>IntelliFlash (default: one flash every 1 second)</p> <ul style="list-style-type: none"> One flash every 1-120 seconds (flash frequency is defined with IntelliFlash Interval option) <p>Heartbeat</p> <ul style="list-style-type: none">  pulses once every second to verify detector is operating correctly 	 <p><i>Note: Confidence/compliance beep and IntelliFlash automatically deactivate during a low battery alarm, calibration fail, bump test fail, self-test fail, and in an alarm condition.</i></p>
<p>Critical Battery Alarm</p> <ul style="list-style-type: none"> Fifteen minutes after low battery alarm activates, sequence of 10 rapid sirens and alternating flashes with 1 second of silence in between (sequence reactivates seven times) Vibrator alarm pulses Low Battery Powering Off displays and the detector deactivates 		<p style="text-align: center;"><i>Note</i></p> <p><i>If the Low Alarm Acknowledge option is enabled, the audible alarm can be disabled during a low alarm condition. The LED and visual alarm indicators remain active until the alarm condition changes or the detector deactivates. Press  to acknowledge the low alarm and deactivate the audible alarm. If the alarm escalates to a high, TWA, or STEL alarm, the audible alarm reactivates.</i></p>	

User Options and Sensor Configuration

In order to modify user options and detector configuration, the following items are required:

- Detector
- IR Link adapter or MicroDock II
- Fleet Manager II software

The following section describes some of the configuration options available in the detector. Refer to the *GasAlertQuattro Technical Reference Guide* and *Fleet Manager II Operator's Manual* for complete information.

Device Configuration

The Device Configuration section displays data about the detector, allows for a startup message to be entered, and defines and enables/disables settings for the detector.

- **Serial Number Field:** This field displays the serial number (e.g. QA111-001000) of the detector.
- **Firmware Version:** This field displays the current firmware version that displays on the detector LCD during the startup sequence. If new firmware is uploaded to the detector, the Firmware Version field automatically updates.
- **Hardware Version:** This field displays the current hardware version of the detector.
- **Startup Message:** Enter text to display on the detector LCD during startup (50 characters maximum). Enter information such as employee name, plant, area, emergency number(s), etc.

- **Lockout on Self-Test Error:** If Lockout on Self-Test Error is enabled and a failure occurs during the self-test, the screen displays **Sensor Self Test Error Lockout Enabled...** and the detector deactivates.
- **Safe Mode:** If enabled, **SAFE** displays continuously on the LCD unless an alarm condition occurs.
- **Confidence/Compliance Beep:** If enabled, the Confidence/Compliance Beep provides continuous audible confirmation that the detector is operating correctly. Frequency of the beep is defined with the Confidence/Compliance Beep Interval option (every **1-120** seconds).

Note

Confidence/Compliance Beep automatically disables during a low battery alarm, self-test fail, calibration fail, bump test fail, and when an alarm event occurs.

- **Latching Alarms:** If enabled, during an alarm condition the **Latching Alarms** option causes the low and high gas alarms (audible, visual, and vibrator) to persist until the alarm is acknowledged and the gas concentration is below the low alarm setpoint. The LCD displays the peak concentration until the alarm no longer exists. Local regulations in your region may require the **Latching Alarms** option be enabled.
- **Force Calibration:** If enabled, during startup if a sensor(s) is past due for calibration, the sensor(s) must be calibrated to continue and enter normal operation.
A value must be entered in the **Cal Interval (days)** field before enabling **Force Calibration**.

- **Force Bump:** If enabled, during startup if the sensor(s) is past due for a bump test, a bump test should be performed and the overdue sensor(s) must enter into alarm.

A value must be entered in the **Bump Interval (days)** field before enabling Force Bump.

- **Cal IR Lock:** If enabled, the sensor(s) can only be calibrated using an IR device (IR Link or the MicroDock II station).

Note

If the Cal IR Lock option is enabled and a manual calibration is attempted, the sensor(s) will auto zero but they will not be calibrated.

- **Flip Display:** The detector can display screens at 0° (upright) or 180° (upside down), depending upon how the detector is worn by the worker. If the **Flip Display** option is enabled, the LCD is viewed at 180° (upside down).
- **Stealth:** When enabled, the following features are disabled: backlight, audible alarms, visual alarms, IntelliFlash, and confidence/compliance beep. Only the vibrator and the LCD readings activate during an alarm condition.

Note

Should the user wish to comply with ATEX performance certifications, stealth mode must be disabled.

- **Datalog Interval:** The **Datalog Interval (seconds)** field defines how often the detector records a datalog (every 1-120 seconds). Enter the desired value.

The total number of 8-hour days datalogs that can be recorded is assuming 90% of the day has no gas concentrations.

When the memory is full, the detector replaces the oldest datalogs with the most recent datalogs.

- **IntelliFlash Interval:** The IntelliFlash Interval (seconds) field defines how often (every 1-120 seconds) the IntelliFlash occurs.
- **Confidence/Compliance Beep Interval:** Define how often (every 1-120 seconds) the confidence/compliance beep occurs.
- **Language:** The Language field provides a drop down menu that includes the following language options: English, Français (French), Deutsch (German), Español (Spanish), Português (Portuguese). Select the language from the drop-down menu in Fleet Manager II.

Sensor Configuration

- **Sensor Disabled:** Enables/disables the selected sensor.

Warning

Use extreme caution when disabling a sensor. The disabled sensor cannot detect and alarm against the applicable gas.

- **Calibration Gas (ppm):** Define the span gas concentration for each sensor. The span gas concentration must match the span value on the gas cylinder.
- **Calibration Interval:** Define how often a sensor should be calibrated (0-365 days) in the **Calibration Interval (days)**

field. A different calibration interval can be defined for each sensor.

⚠ Caution

BW recommends that the sensors be calibrated at least once every 180 days (6 months).

- **Bump Interval:** Define how often a bump test should be performed for each sensor (**0-365** days) in the **Bump Interval (days)** field. A different bump interval can be defined for each sensor.
- **Low Alarm:** Define the low alarm setpoints for each sensor. Refer to *Sample Gas Alarm Setpoints* for factory defined alarm setpoints in the GasAlertQuattro Technical Reference Guide.
- **High Alarm:** Define the high alarm setpoints for each sensor. Refer to *Sample Gas Alarm Setpoints* for factory defined alarm setpoints in the GasAlertQuattro Technical Reference Guide.
- **TWA Alarm:** The time-weighted average (TWA) is a safety measure used to calculate accumulated averages of gases. Using the US Occupational Safety and Health Administration (OSHA) method or the American Conference of Governmental Hygienists (ACGIH) method, an average is calculated to ensure the detector alarms when the TWA has accumulated.
- **STEL Alarm:** The short-term exposure limit (STEL) is the maximum permissible gas concentration a worker can be safely exposed to for short periods of time (**5-15** minutes maximum).

- **Correction Factor (LEL):** The Correction Factor option defines compensation factors for hydrocarbons other than methane. The correction factor is only applicable to LEL and can only be applied if the LEL sensor has been calibrated with methane. Detector operation using LEL correction factors has not been tested by BAM.
- **STEL Interval:** Define the short-term exposure limit (STEL) from 5-15 minutes (toxic sensors only).
- **TWA Period (hours):** Define the time-weighted average (TWA) from **4-16** minutes (toxic sensors only).
- **TWA Method:** Select either the US Occupational Safety and Health Administration (OSHA) or the American Conference of Governmental Industrial Hygienists (ACGIH) TWA calculating method.
- **50% LEL = (%CH4):** Enter a percentage value to display the LEL reading as %vol., assuming a methane environment (LEL only).
- **Auto Zero on Startup:** When enabled, the sensors automatically zero during the startup sequence. The Auto Zero on Startup option is available for the CO, H₂S, LEL, and O₂ sensors (each sensor is enabled individually).
- **LEL by Volume CH4:** If enabled, the detector displays the LEL value as %vol. assuming a methane environment.

Note

*If changing the measurement unit from % LEL to % Vol. or from % Vol. to % LEL, a calibration must be completed and the alarm setpoints changed. For calibration information refer to **Calibration** on page 9 and for alarm setpoint information refer to **Gas Alarm***

Setpoints in the GasAlertQuattro Technical Reference Guide.

- **10% LEL (of reading) Over-span:** If enabled, the detector automatically over-spans the LEL sensor by 10% of the span concentration. Enable 10% LEL (of reading) Over-Span to ensure the detector is in compliance with CAN/CSA C22.2 No. 152.
- **20.8 Base Reading:** If enabled, the detector is configured to detect 20.8% O₂ as ambient air. When disabled, the detector is configured to detect 20.9% O₂ as ambient air.
- **Low Alarm Acknowledge:** If enabled, the audible alarm can be temporarily disabled during a low alarm by pressing . The vibrator, alarm LEDs, and LCD remain operational (toxic and LEL only).

Maintenance

To maintain the detector in good operating condition, perform the following basic maintenance as required.

- Calibrate, bump test, and inspect the detector on a regular schedule.
- Maintain an operations log of all maintenance, bump tests, calibrations, and alarm events.
- Clean the exterior with a soft damp cloth. Do not use solvents, soaps, or polishes. Refer to **Sensor Poisons and Contaminants**.

Rechargeable Battery Capacity

A rechargeable battery's runtime decreases approximately 20% over a two-year period of typical use.

Battery Pack Retaining Screw

The retaining screw (QAQD-20x) provided with the detector must be used to lock the battery pack on all European and IECEx scheme detectors, and on all Canadian and U.S. Zone Certified detectors.

The screwdriver included with the detector has a double-ended driver. Loosen the brass nut to switch between a Phillips head and a hex head.

A hex tool is required to tighten and loosen the retaining screw. Tighten the screw 1-2 turns using 3-4 in-lbs of torque. Do not overtighten the screw.

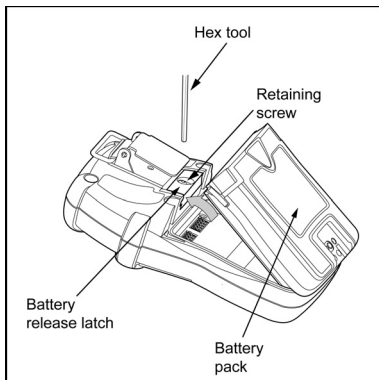

Replacing the Battery Pack

The alkaline and rechargeable battery packs can be changed in hazardous locations.

1. Press and hold  to deactivate the detector.
2. If using the retaining screw, loosen it 1-2 turns. Push the battery release latch toward the top of the detector to release the battery pack.
3. From the top of the battery pack, lift upward to remove.

4. Before replacing the battery pack, ensure the seal on the instrument and battery pack is free of debris and moisture.
5. Insert a new battery pack. Insert the bottom of the battery pack first, then lower the top into place. Press until the release tab engages. Tighten the retaining screw if required.

Charging the Rechargeable Battery Pack

⚠ Warning

To avoid personal injury and/or damage to the detector, adhere to following:

Charge only in a safe area that is free of hazardous gas within temperatures of 32°F to 104°F (0°C to 40°C).

Charge the battery immediately when the detector emits a low battery alarm.

Charge the lithium battery pack using the BW supplied charger and charger adapter only. The charging adapter is specific to your region. Use of the charging adapter outside your region will damage the charger and the detector. Failure to adhere to this caution can lead to fire and/or explosion.

Charge the lithium battery after each workday.

Ensure the charging connector surface is free of debris and moisture.

1. Press and hold  to deactivate the detector, then plug the charger into an AC outlet.

Note

The time required to charge will increase if the detector is activated.

2. Connect the charging adaptor to the detector IR receptacle. Refer to the following illustration.

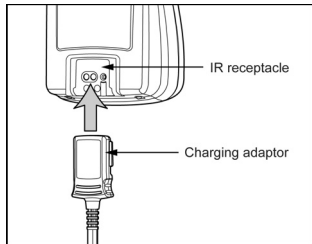

3. The lithium battery may require 6 hours to reach full capacity.

Replacing the Alkaline Batteries

⚠ Warning

To avoid personal injury and/or damage to the detector, use only BW recommended alkaline batteries. Refer to *Specifications*.

Change the alkaline batteries only in safe area that is free of hazardous gas.

1. Press and hold  to deactivate the detector.
2. If using the retaining screw, loosen the retaining screw 1-2 turns. Remove the alkaline battery pack. Refer to ***Replacing the Battery Pack***.
3. Unhook the ejector bar from the release clasp. Move the ejector bar towards the top of the battery pack until it is aligned horizontally over the batteries.

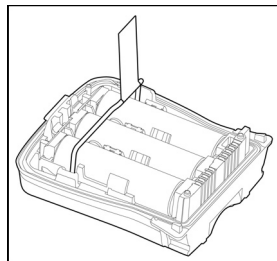

GasAlertQuattro
Operator's Manual

4. Using the tab, pull on the ejector bar.

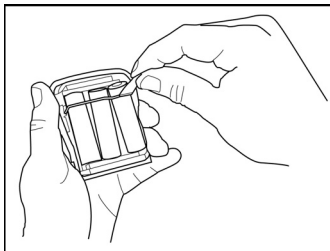

5. To the left of the tab, pull up on the ejector bar.

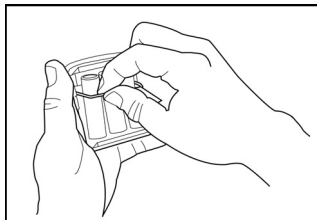

6. Remove the spent batteries. Reset the ejector bar to its original flat position. Ensure the ejector bar engages the release clasp.

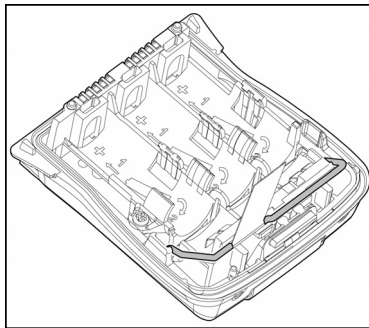

7. Insert the new batteries. Position the positive end of the battery at a 30° angle and insert into the battery pack before pushing the negative end down. Ensure the batteries are not inserted over the tab.

Note

Ensure all three batteries are inserted with the positive end pointing toward the top of the battery pack.

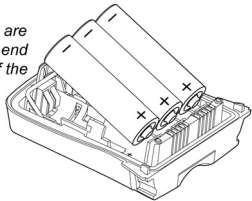

8. Before replacing the battery pack, ensure the seal on the instrument and battery pack is free of debris and moisture.
9. Replace the battery pack by inserting the bottom first, then lower top into place. Ensure the tab is tucked in before replacing the battery pack.
Press until the release tab engages. If required, tighten the retaining screw using 3-4 in. lbs torque.

WEEE Directive and Battery Directive

Failure to comply with the following battery removal and disposal instructions may result in battery shorting, battery leakage, and/or other damage. Ensure a qualified technician completes the following procedures.

Removal and Disposal of the Alkaline Battery Pack

Only a qualified technician should complete the following procedures.

To remove the alkaline batteries, refer to steps #1 to #6 in **Replacing the Alkaline Batteries** on pages 21 and 22.

Removal and Disposal of the Rechargeable Battery Pack

To remove the rechargeable battery pack, refer to steps #1 to #3 in **Replacing the Battery Pack** on page 20.

Dispose of the battery pack according to local laws.

Removal and Disposal of the Coin Cell

The detector contains a coin cell to power the real-time clock. Only a qualified technician should complete the following procedure.

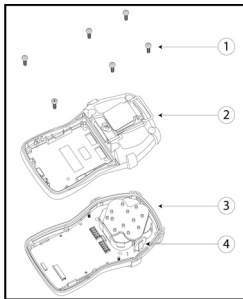

Item	Description
1	Rear machine screws (6)
2	Rear shell
3	Front shell and PCB
4	Coin cell

1. Press and hold  to deactivate the detector.
2. If the battery pack has not yet been removed, refer to **Removal and Disposal of the Alkaline Battery Pack** on page 23 or **Removal and Disposal of the Rechargeable Battery Pack** on page 23.
3. Remove the six machine screws on the rear shell.
4. Remove the two screws on the main PCB.
5. Remove the main board.
6. The coin cell is connected to the board by four leads.

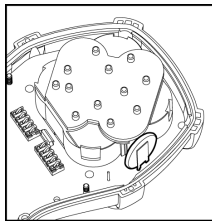

7. Clip the four leads individually to remove the coin cell.

⚠ Caution

Do not touch two or more leads when disconnecting the battery cell.

8. Dispose of the coin cell according to local laws.

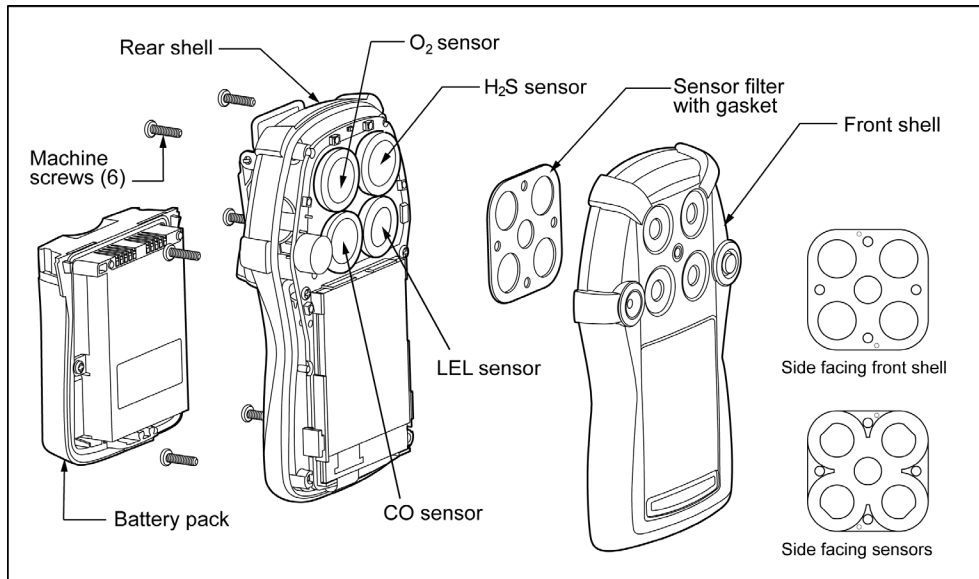
Replacing the Sensors

⚠ Warning

To avoid personal injury and/or property damage, only use sensors that are specifically designed for the detector.

Replace the sensors in a non-hazardous area.

Note

Detectors that are configured for 1, 2, or 3 gases may contain a dummy sensor in one of the four sensor locations.

To replace a sensor or sensor filter, refer to the illustration

Replacing the Sensors and the following steps #1-8.

1. Press and hold  to deactivate the detector. Press the release latch, and remove the battery pack.
2. Remove the six machine screws from the rear shell.
3. Remove the front shell.
4. Remove the spent sensor(s). Ensure no damage occurs to the LCD.
5. Insert the new sensor(s).
6. Before reassembling the detector, ensure the sealing surfaces on the front and rear shells is free of debris and moisture.
7. Reassemble the detector. Press the front and rear shells together firmly to ensure a proper seal. Ensure the front and rear shells have a tight, uniform 1/16 in. (1.5 mm) seal on all sides of the detector.

8. Replace the six machine screws using 3-4 in. lbs torque. Do not overtighten the screws. Replace the battery pack.
9. New sensors must be calibrated prior to use. Calibrate the new sensor(s) immediately. Refer to **Calibration**.

Replacing the Sensor Filter

To replace the filter, refer to the illustration **Replacing the Sensors** on page 25 and the following steps #1-6.

1. Press and hold  to deactivate the detector. Press the release latch, and remove the battery pack.
2. Remove the six machine screws from the rear shell.
3. Remove the front shell. Remove the sensor filter.
4. Refer to the following illustration before inserting the new filter. Ensure the filter is laying flat and that the holes are correctly aligned over the filter posts.

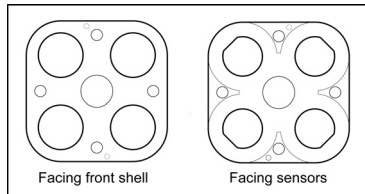

5. Before reassembling the detector, ensure the sealing surfaces on the front and rear shells is free of debris and moisture.
6. Replace the front shell. Press the front and rear shells together firmly to ensure a proper seal. Ensure the front and rear shells have a tight, uniform 1/16 in. (1.6 mm) seal on all sides of the detector.
7. Replace the six machine screws using 3-4 in. lbs torque. Do not overtighten the screws. Replace the battery pack.

Specifications

Instrument dimensions: 13 x 8.1 x 4.7 cm
(5.1 x 3.2 x 1.5 in.)

Weight:
316 g (11.15 oz.) with rechargeable battery pack
338 g (11.92 oz.) with alkaline battery pack

Operating temperature: -20°C to +50°C (-4°F to +122°F)

Storage temperature: -40°C to +60°C (-40°F to +140°F)

Operating humidity: 10% to 100% relative humidity
(non-condensing)

Operating environment specifications for use according to ATEX performance approvals

(Oxygen and methane measurements)

Operating temperature range certified by BAM: -20°C to +50°C

Operating humidity as tested by BAM: 5% r.H. to 95% r.H.

(Extended Range of Use for Temperature and Humidity as Compared To EN 50104 (Oxygen performance) and EN 67009-29-1 (LEL performance))

Storage temperature range tested by BAM: -25°C to +60°C

Operating pressure as tested by BAM: 80 kPa to 120 kPa

Storage duration: Two years from purchase date

GasAlertQuattro

Operator's Manual

Dust and moisture ingress: IP66/67 (with screw engaged)

Alarm setpoints: May vary by region and are user-defined

Detection range:

H₂S: 0 - 200 ppm (0.1 ppm increments from 0.0 to 39.9 ppm / 1 ppm increments above 40 ppm)

CO: 0 - 1000 ppm (1 ppm increments)

O₂: 0 - 30.0% vol. (0.1% vol. increments)

Combustible (LEL): 0 - 100% (1% LEL increments) or 0 - 5.0% v/v methane

Sensor type:

H₂S, CO, O₂: Single plug-in electrochemical cell

Combustibles: Plug-in catalytic bead

O₂ measuring principle: Capillary controlled concentration sensor

Bump test specified limits: BW recommends using a gas cylinder that will ensure the combustible sensor has an accuracy of -0 to +20% of actual reading (reference CAN/CSA C22.2 No. 152)

Alarm conditions: TWA alarm, STEL alarm, low alarm, high alarm, multi alarm, over limit (OL) alarm, low battery alarm, critical low battery alarm, sensor failure alarm, IntelliFlash, confidence/compliance beep

Audible alarm: 95 dB at 30 cm (12 in.) variable pulsed beeper

Visual alarm: Red light-emitting diodes (LEDs)

IntelliFlash: Green light-emitting diode. Flash frequency is user-defined with IntelliFlash interval option

Confidence/compliance beep: Audible beep from variable pulsed beeper. Beep frequency is user-defined with confidence/compliance beep interval option

Display: Alphanumeric liquid crystal display (LCD) with flip display (0° or 180°) capability (user-defined in Fleet Manager II)

Backlight: Activates upon startup and deactivates when self-test is complete. Activates when the pushbutton is pressed and deactivates after 10 seconds. Also activates during an alarm condition and remains lit until alarm ceases

Internal vibrator: Vibrates during activation, deactivation, and all alarms

Self-test: Initiated during activation, self-test runs continuously on the battery and electrochemical sensors (H₂S and CO) while detector is operational

Calibration: Zero and automatic span

User options: Startup message, lockout on self-test error, safe mode, IntelliFlash, confidence/compliance beep, latching alarms, force calibration, force bump, calibration IR lock, flip display, stealth mode, datalog interval, IntelliFlash interval, confidence/compliance beep interval, and language selection

Sensor options: Sensor enable/disable, calibration gas values, calibration interval, bump test interval, alarm setpoints (low/high/TWA/STEL), STEL interval, TWA period, auto zero at startup enable/disable, LEL correction factor, 10% (of reading) over-span, low alarm acknowledge, O₂ measurement, LEL gas measurement, %vol methane measurement

Year of manufacture: The detector's year of manufacture is determined from the serial number. The second and third number after the second letter determines the year of manufacture. E.g., QA111-001000 = 2011 year of manufacture

Approved lithium battery for GasAlertQuattro product: Lithium-ion polymer (QT-BAT-R01) as per standards UL913, EN60079-11, EN60079-0, IEC 60079-0, IEC 60079-11, EN 60079-29-1, EN 50104, and C22.2 No. 157

Rechargeable battery (QT-BAT-R01) **Temperature code**
Lithium polymer $-20^{\circ}\text{C} \leq \text{Ta} \leq +50^{\circ}\text{C}$ T4

Lithium battery operating time: One rechargeable lithium polymer battery provides the following operating runtimes:

20 hours at 20°C (68°F)
18 hours at -20°C (-4°F)

Lithium Battery operating time (ATEX performance approval): 26 hours

(tested according to EN 60079-29-1 (2007) and EN 50104 (2010)).

Approved alkaline battery pack for GasAlertQuattro (QT-BAT-A01): as per standards UL913, EN60079-11, EN60079-0, EC 60079-0, IEC 60079-11, C22.2 No. 157

Approved alkaline batteries for GasAlertQuattro product:

Duracell MN1500 $-20^{\circ}\text{C} \leq \text{Ta} \leq +50^{\circ}\text{C}$ T4 (129.9°C)
Energizer E91VP $-20^{\circ}\text{C} \leq \text{Ta} \leq +50^{\circ}\text{C}$ T3C (135.3°C)

AA alkaline battery operating time:
14 hours at 20°C (68°F)

Battery charger: Charging adapter

First-time charge: 6 hours

Normal charge: 6 hours

Warranty: 2 years including sensors

EC Declaration of Conformity:

http://www.gasmonitors.com/Declarations_of_Conformity

Approvals:

Approved by CSA to both U.S. and Canadian Standards CAN/CSA C22.2 No. 157 and C22.2 152 ANS/UL - 913 and ANSI/ISA - S12.13 Part 1

CSA Class I, Division 1, Group A, B, C, D

ATEX CE 0539 Ex II 1 G Ex ia IIC Ga T4 for Zone 0 Group IIC

KEMA 09 ATEX 0137
EN 60079-0, EN 60079-11, EN 60079-26

IECEX Ex ia IIC T4Ga IECEX CSA 09.0006

IEC 60079-0, IEC 60079-11, IEC 60079-26

BAM BAM 11 ATEX 1102 X EN 60079-29-1
(for 0 up to 100% LEL methane)

BAM/ZBF/006/11 EN 50104
(for 0 up to 25% v/v oxygen)

Firmware Release version GAQF_03_000

This equipment has been tested and found to comply with the limits for a Class B digital device, pursuant to Part 15 of the FCC Rules and ICES-003 Canadian EMI requirements. These limits are designed to provide reasonable protection against harmful interference in a residential installation. This equipment generates, uses and can radiate radio frequency energy and, if not installed and used in accordance with the instructions, may cause harmful interference to radio communications. However, there is no guarantee that interference will not occur in a particular installation. If this equipment does cause harmful interference to radio or television reception, which can be determined by turning the equipment off and on, the user is encouraged to try to correct the interference by one or more of the following measures:

- Reorient or relocate the receiving antenna.
- Increase the separation between the equipment and receiver.
- Connect the equipment into an outlet on a circuit different from that to which the receiver is connected.
- Consult the dealer or an experienced radio/TV technician for help.

ATEX Performance Approval

Special conditions for safe use

To comply with ATEX performance approval requirements, the detector must be operated in the following manner:

Operating manual: Read and understand the operating manual. It is essential that the instructions for correct use are followed.

Instrument power-up: The instrument must be powered up in a safe area that is free of hazardous gas and in an atmosphere of 20.9% oxygen. The detector must be turned on and verified to be operating in the normal measurement mode before it can be brought into a hazardous area.

Low-battery alarm: In the event of a low-battery alarm, the user must leave the hazardous area immediately.

Operating environment: The operating environment ranges that apply for use of the GasAlertQuattro according to ATEX performance approvals for LEL and oxygen measurements are shown in **Specifications** on page 27. These specify the climatic range within which the instrument can be used in conformity to the performance certifications.

General use: For use only in potentially explosive atmospheres where oxygen concentrations do not exceed 20.9% (v/v). Oxygen deficient atmospheres (<10% v/v) may suppress some sensor outputs.

Daily bump test: To comply with ATEX performance certification requirements, a bump test must be completed before each day's use.

Calibration: To minimize measuring errors, the ambient conditions of temperature, humidity, and pressure during calibration should be as close as possible to the actual environmental conditions in which the instrument is intended to be used.

Calibration interval: If the detector is to be used in atmospheres which may contain compounds known to interfere with, inhibit, or poison the sensors, the calibration intervals must be specified to take into account the possibility of a rapid loss in measurement sensitivity. See page 7, **Sensor Poisons and Contaminants**.

Sensor impairment: Some types and concentrations of dust in the monitored atmosphere may impair the measuring function of the gas detector. Cross-sensitivities described in the sensor manufacturer's data sheet must be considered.

Response time verification: Before use, confirm that the gas detector's response time is fast enough to trigger alarms so that unsafe situations are avoided. If necessary, set the alarm levels below the standard safety-related limit values to allow enough time for protective measures to be carried out.

Instrument configuration: FleetManager II version 2.6.0 (or higher) must be used to make configuration changes to the GasAlertQuattro

To operate the instrument in accordance with ATEX gas performance configuration requirements:

- Latching alarms must be enabled. See page 16.
- Stealth mode must be disabled. See page 17.
- Force Bump must be enabled. See page 12.
- Bump Interval (days) must be set to 1 for all sensors.
- IntelliFlash must be enabled. See page 17.
- LEL Low Alarm and High Alarm values cannot be 0.

Special conditions for safe use - oxygen measurement

Performance approval: The EC type examination certificate applies to the measurement of oxygen up to 25% (v/v).

Baseline and span zone blanking: Please note that oxygen measurements in the range from 20.5% (v/v) up to 21.3% (v/v) are indicated as "20.9%" oxygen on the instrument display. Measurement values in the range within $\pm 0.2\%$ (v/v) of the span gas concentration are displayed as the span gas concentration. For example, if the span gas concentration (used for oxygen bump testing) is configured as 18% (v/v), measured values in the range of 17.8% (v/v) to 18.2% (v/v) will be indicated as "18.0%" oxygen on the instrument display.

Oxygen measurement performance as tested by BAM

Oxygen response time t_{90} : 15 seconds for oxygen deficiency

Oxygen response time t_{90} : 15 seconds for oxygen enrichment

Measurement stabilization time: ≥ 120 seconds

Instrument warmup time: 32 seconds

Special conditions for safe use - LEL measurement

Performance approval: The EC type examination certificate for LEL measurement applies only to the measurement of methane from 0% to 100% of the Lower Explosion Limit. The LEL of methane is equal to 4.4% (v/v) methane in air. Additional tests of a notified body would be required in addition to this certificate for ATEX performance approval of the GasAlertQuattro with respect to other combustible gases.

Effect of other toxic gases on the LEL sensor: If substances (e.g. sensor poisons) that could interfere with and affect the sensitivity of the sensing device are to be expected in the atmosphere to be monitored which may cause a rapid change of sensitivity, the calibration interval shall be reduced.

Measuring gases of other installed measuring channels of the GasAlertQuattro (e.g. hydrogen sulphide) may decrease the sensitivity of the LEL sensor. The calibration interval should be reviewed taking into account any degradation in performance.

Methane LEL measurement performance as tested by BAM

Methane response time t_{90} : 15 seconds

Stabilization time for methane sensor: \geq 120 seconds

Warmup time: 32 seconds

LEL correction factors: Detector operation using LEL correction factors has not been tested by BAM

Changing measurement range from % LEL to % Vol.: If changing the measurement unit from % LEL to % Vol. or from % Vol. to % LEL, a calibration must be completed and the alarm setpoints changed. For calibration information refer to **Calibration** on page 9 and for alarm setpoint information refer to **Gas Alarm Setpoints** in the GasAlertQuattro Technical Reference Guide.

Measuring values from -6% LEL to +3% LEL are indicated as "0% LEL" in the measuring mode. Measuring values in the \pm 3% LEL ranges of the configured span gas concentration are indicated as the configured span gas concentration.

Troubleshooting

If the problem persists, contact BW Technologies by Honeywell.

Problem	Possible Cause	Solution
Startup		
The detector does not activate.	Depleted batteries	Replace alkaline batteries. Refer to <i>Replacing the Alkaline Batteries</i> on page 21.
		Refer to <i>Charging the Rechargeable Battery Pack</i> on page 20.
	Damaged detector	Contact BW Technologies by Honeywell.
Detector automatically deactivates.	Automatic deactivation due to critical low battery.	Replace alkaline batteries. Refer to <i>Replacing the Alkaline Batteries</i> on page 21.
		Refer to <i>Charging the Rechargeable Battery Pack</i> on page 20.
	Lockout on Self-Test Error is enabled and a sensor(s) has failed the startup self-test.	Refer to Replacing the Sensor on page 25 and <i>Lockout on Self-Test Error</i> in the GasAlertQuattro Technical Reference Guide.
	Sensor(s) requires calibration.	Refer to <i>Calibration</i> on page 9.

Problem	Possible Cause	Solution
The detector enters alarm immediately when activated.	Sensor needs to stabilize.	Used sensor: Wait 60 seconds New sensor: Wait 5 minutes
	Low battery or critical low battery alarm.	Replace alkaline batteries. Refer to Replacing the Alkaline Batteries on page 21.
		Refer to Charging the Rechargeable Battery Pack on page 20.
	Hazardous environment.	Leave the area immediately. Deactivate and reactivate the detector in a safe area that is free of hazardous gas, in an atmosphere of 20.9% oxygen.
The activation startup self-test fails.	General fault.	Contact BW Technologies by Honeywell.
	Sensor error.	Refer to Startup Troubleshooting . If required, refer to Replacing the Sensors on page 25.
Detector Operation		
Detector does not display normal gas reading after startup sequence.	Sensors not stabilized.	Used sensor: Wait 60 seconds New sensor: Wait 5 minutes
	Sensor(s) requires calibration.	Refer to Calibration on page 9.
	Target gas is present.	Detector is operating properly. Use caution in suspect areas.

Problem	Possible Cause	Solution
Detector does not respond to pushbutton.	Battery is in critical low battery state or is completely depleted.	Replace alkaline batteries. Refer to Replacing the Alkaline Batteries on page 21.
		Refer to Charging the Rechargeable Battery Pack on page 20.
	Detector is performing operations that do not require user input.	Pushbutton operation restores automatically when the operation ends.
Detector does not accurately measure gas.	Sensor(s) requires calibration.	Refer to Calibration on page 9.
	Detector is colder/hotter than gas temperature.	Allow the detector to attain ambient temperature before use.
	Sensor filter is blocked.	Refer to Replacing the Sensor Filter on page 26.
Detector does not enter alarm.	Alarm setpoint(s) are set incorrectly.	Refer to Sample Gas Alarm Setpoints in the GasAlertQuattro Technical Reference Guide. Define the alarm setpoints in Fleet Manager II.
	Alarm setpoint(s) set to zero.	Refer to Sample Gas Alarm Setpoints in the GasAlertQuattro Technical Reference Guide. Define the alarm setpoints in Fleet Manager II.
	Detector is in calibration mode.	Complete the calibration procedure.

Problem	Possible Cause	Solution
Detector intermittently enters alarm without reason.	Ambient gas levels are near alarm setpoint or the sensor is exposed to a puff of the target gas.	Detector is operating normally. Use caution in suspect areas. Check peak gas exposure reading.
	Alarm setpoints are set incorrectly.	Refer to <i>Sample Gas Alarm Setpoints</i> in the GasAlertQuattro Technical Reference Guide. Define the alarm setpoints in Fleet Manager II.
	Sensor(s) requires calibration.	Refer to Calibration on page 9.
	Missing or faulty sensor(s).	Refer to Replacing the Sensors on page 25.
Features and options are not operating as expected.	Changes in Fleet Manager II.	Verify that the settings in Fleet Manager II are correct.
Charging		
Battery has been charging for 6 hours. Charging indicator on LCD shows the battery is still charging.	Battery is trickle charging.	Battery is fully charged and is ready for operation.
Battery indicator does not display when charging.	Battery is depleted below normal levels	Charge the battery for 8 hours. If the battery indicator does not light after charging, contact BW Technologies by Honeywell.

Startup Troubleshooting

Table 1: Startup Troubleshooting







Error Screen	Problem	Solution	Error Screen	Problem	Solution
	<p>Auto-zero Error Sensor(s) failed to auto-zero</p>	<p>Calibrate the sensor.</p>		<p>Last Calibration Failed Displays when the last calibration failed. If the Force Calibration option is enabled, the sensors must be calibrated.</p>	<p>Press  and calibrate the sensor(s) immediately. Refer to Calibration on page 9. If Cal IR Lock is enabled, an IR device (IR Link or MicroDock II) must be used to calibrate.</p>
	<p>Self-test Failed Sensor(s) fails the self-test during startup.</p>	<p>Press  to accept the failed sensor(s). The Sensor self test error accepted screen displays. Replace the sensor when startup is complete. Refer to Replacing the Sensors on page 25.</p>		<p>Force Calibration If the Force Calibration option is enabled, the sensors must be calibrated to enter normal operation.</p>	<p>Press and hold  to calibrate the sensors, or press  and release to deactivate the detector. Refer to Calibration on page 9. If Cal IR Lock is enabled, an IR device (IR Link or MicroDock II) must be used to calibrate.</p>

Table 1: Startup Troubleshooting

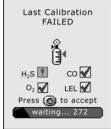



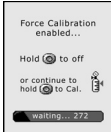

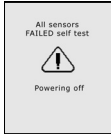
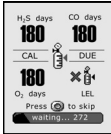

Error Screen	Problem	Solution	Error Screen	Problem	Solution
 <p>All sensors FAILED self test</p> <p>Powering off</p>	<p>All Sensors Fail If the Lockout on Self-test Error option is enabled and all sensors fail, the detector automatically deactivates.</p>	<p>A failure of all sensors can be caused by poisoning (alcohol and silicon). Allow sensors to recover for 1 hour. If sensors fail startup again, refer to Replacing the Sensors on page 25.</p>	 <p>H₂S days 180 CO days 180</p> <p>CAL DUE</p> <p>O₂ days LEL</p> <p>Press to skip</p> <p>waiting... 272</p>	<p>Calibration Overdue Displays when calibration is past due. If the Force Calibration option is enabled, the sensor(s) must be calibrated to enter normal operation.</p>	<p>Press <input type="button" value="O"/> to continue and calibrate the sensor(s) immediately. Refer to Calibration on page 9.</p> <p>If Cal IR Lock is enabled, an IR device (IR Link or MicroDock II) must be used to calibrate.</p>
 <p>Last Bump Test FAILED</p> <p>H₂S CO</p> <p>O₂ LEL</p> <p>Press to accept</p> <p>waiting... 272</p>	<p>Last Bump Test Failed If the last bump test failed and the Force Bump Test option is enabled, a bump test must be performed.</p>	<p>Use the MicroDock II station to perform a bump test, otherwise press <input type="button" value="O"/> to deactivate the detector. If you do not have a MicroDock II, change the bump interval in Fleet Manager II, refer to Bump Test on page 12.</p>	 <p>Bump Test due Use MicroDock or apply gas now</p> <p>H₂S CO</p> <p>O₂ LEL</p> <p>Press to ignore</p> <p>waiting... 272</p>	<p>Bump Test Overdue Screen displays when sensors are overdue for a bump test and the Force Bump test option is disabled.</p>	<p>Apply gas directly or use the MicroDock II, otherwise press <input type="button" value="O"/> to enter normal operation with the bump test overdue. Refer to Bump Test on page 12.</p>

Table 1: Startup Troubleshooting

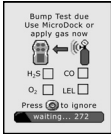
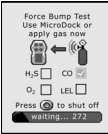
Error Screen	Problem	Solution	Error Screen	Problem	Solution
	<p>Force Bump Test If the Force Bump Test option is enabled, the sensors must be bump tested to enter normal operation.</p>	<p>Apply gas immediately or use the MicroDock II station, otherwise press  to deactivate the detector.</p> <p>Refer to Bump Test on page 12.</p>		<p>⚠ Caution</p> <p>BW Technologies by Honeywell recommends to bump test the sensors before each day's use to confirm their ability to respond to gas by exposing the detector to a gas concentration that exceeds the alarm setpoints.</p>	

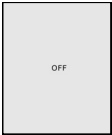
Calibration Troubleshooting

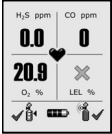
Table 2:

Error Screen	Problem	Solution	Error Screen	Problem	Solution
	<p>Detector deactivates while trying to calibrate</p> <p>Detector does not enter calibration. Displays OFF and then deactivates.</p>	<p>Calibrate the sensor.</p>		<p>Cal IR Lock Enabled</p> <p>IR lock enabled screen displays.</p>	<p>An IR device must be used to calibrate (IR Link or MicroDock II). For manual calibration, refer to <i>Calibrating Using an IR Device</i> in the GasAlertQuattro Technical Reference Guide. For automated calibration, refer to the MicroDock II User Manual.</p>
	<p>Self-test Fail</p> <p>If a sensor(s) fails auto zero, an error message displays showing which sensor(s) failed.</p>	<p>Replace the sensor or contact BW Technologies by Honeywell. Refer to Replacing the Sensors on page 25.</p>		<p>Calibration Error</p> <p>Insufficient amount of gas detected.</p>	<p>Verify the span gas values on the cylinder match the span gas values set for the detector. Ensure gas is applied at a flow rate of 250-500 ml/min. Ensure cylinder is not empty or expired. Replace immediately if required. Replace the regulator if required.</p>

Bump Test Troubleshooting

For bump test troubleshooting recommendations, refer to **Table 1, Startup Troubleshooting**.

Replacement Parts and Accessories

⚠ Warning

To avoid personal injury and/or damage to the detector, use only the specified replacement parts.

To order parts or accessories, contact BW Technologies by Honeywell.

Table 3. Replacement Parts and Accessories

Model No.	Description	Qty
Sensors		
SR-W04-75C	Combustible (LEL) sensor	1
SR-X10-C1	Oxygen (O ₂) sensor	1
SR-M04-SC	Carbon monoxide (CO) sensor	1
SR-H04-SC	Hydrogen sulfide (H ₂ S) sensor	1
Sensor Filters		
QT-SS	Sensor filters (kit of 2)	1
QT-SS-K1	Sensor filters (kit of 10)	1
Regulators		
REG-DF-1	Demand flow regulator	1
REG-0.5	0.5 l/min regulator	1

Model No.	Description	Qty
Gas Cylinders and Kits		
CG-Q58-4	Quad gas cylinder: CH ₄ -2.5%, O ₂ -18.0%, H ₂ S-25 ppm, CO-100 ppm, bal. N ₂ (58 l)	1
CG-Q34-4	Quad gas cylinder: CH ₄ -2.5%, O ₂ -18.0%, H ₂ S-25 ppm, CO-100 ppm, bal. N ₂ (34 l)	1
CG-T34	Dual gas cylinder: 50% LEL (CH ₄ -2.5%) O ₂ -20.9%, bal. N ₂ (34 l)	1
G0042-H25	Single gas cylinder: H ₂ S 25 ppm, bal. N ₂ (58 l)	1
CG2-M-200-103	Single gas cylinder: CO 200 ppm, bal N ₂ (103 l)	1
CG-BUMP1	Bump alarm gas aerosol (CH ₄ -2.5%, O ₂ -10%, H ₂ S-40 ppm, CO-200 ppm)	1
CK-Q34-4	Quad calibration kit with regulator, quad gas cylinder (CG-Q34-4), hose, and carrying case	1
CK-Q58-4	Quad calibration kit with regulator, quad gas cylinder (CG-Q58-4), hose, and carrying case	1

Model No.	Description	Qty
QT-TC-1	Calibration cap	1
Battery Packs		
QT-BAT-R01	Rechargeable lithium battery pack	1
QT-BAT-A01	Alkaline battery pack (batteries included)	1
Chargers and Power Options		
GA-PA-1-MC5	GasAlertQuattro multi-unit power adapter	1
QT-C01-MC5	GasAlertQuattro multi-unit cradle charger	1
GA-VPA-1	Vehicle power adapter	1
GA-PA-1	Replacement power adapter	1
IR Devices		
GA-USB1-IR	GasAlertQuattro IR connectivity kit	1
DOCK2-2-1 C1N-00-N	GasAlertQuattro docking module	1
MicroDock II station (w/ charging cable)		
DOCK2-0-1 C1N-00-N	GasAlertQuattro docking module w/ charging cable	1
Accessories		
GA-BQT	Concussion proof boot	1
GA -HQT	Carrying holster	1

Model No.	Description	Qty
QT-AF-K1	Auxiliary Filter w/ LCD protector (with 1 filter)	1
QT-SS-AF-K1	Replacement auxiliary filters (kit of 5 filters)	1
QT-VMB-1	Vehicle mount attachment	1
XT-AG-1	Alligator clip (stainless steel)	1
GA-NS-1	Neck strap w/ safety release	1
GA-LY-1	Short strap 6 in. (15.2 cm)	1
GA-ES-1	Extension strap 4 ft. (1.2 m)	1
GA-ARM-1	Arm band	1
GA-CH-2	Chest harness	1
SPAK-CC1	Hard sided carrying case for GasAlertQuattro and/or motorized Sampling Pump	1
Replacement Parts		
QT-SCREW-K1	Replacement screw kit (40 screws and screwdriver)	1

**Add one of the following applicable suffixes to the end of the order number to ensure power adapter is correct for region.*

(-UK) for United Kingdom

(-EU) for Europe

(-AU) for Australia/China

CONTACT INFORMATION

GasTech Australia Pty Ltd
24 Baretta Rd
Wangara Western Australia 6065
Tel 1800 999 902
Fax 1800 999 903
<http://www.gastech.com.au>



Wear yellow. Work safe.