

D-GUARD²



65-1080G-XXX
65-1080R-XXX

65-1080S-XXX

USER MANUAL

This manual is for model variants:

D-GUARD²G



65-1080G-XXX

D-GUARD²R



65-1080R-XXX

D-GUARD²S



65-1080S-XXX

This Page Left Intentionally Blank

MANUAL CONVENTIONS	7
1. WARNINGS, CAUTIONS AND NOTES	7
2. LIMITATIONS OF USE	8
3. PRODUCT MARKINGS	9
4. RECEIVING AND STORAGE	10
4.1. RECEIVING.....	10
4.2. INSPECTION	10
4.3. STORAGE.....	10
5. GASTECH AUSTRALIA CONTACT DETAILS	10
6. GENERAL SAFETY PRACTICES	11
6.1. RELEVANT PERSONNEL.....	11
6.2. SAFETY COMMUNICATION	11
6.3. SAFE USE OF EQUIPMENT.....	11
6.4. MODIFICATIONS TO EQUIPMENT.....	11
6.5. EQUIPMENT KNOWLEDGE.....	11
7. INTRODUCTION	12
7.1. PURPOSE AND CONTENTS OF THIS MANUAL.....	12
7.2. PRODUCT IDENTIFICATION AND TYPE	12
7.3. CONTENTS OF D-GUARD-2 PACKAGE	13
.....	13
8. PRODUCT DESCRIPTION	14
8.1. PRODUCT FUNCTION	14
8.2. DESCRIPTION OF OPERATION	14
9. INSTALLATION	15
9.1. INSTALLATION CONSIDERATIONS	15
9.2. GENERAL INSTALLATION PRACTICES.....	16
9.3. DETECTOR DIMENSIONS AND MOUNTING ORIENTATION	16
9.4. INSTALLATION CONSIDERATIONS.....	17
9.4.1 <i>Power supplies</i>	17
9.4.2 <i>Typical Connection to a power supply and controller</i>	17
9.4.3 <i>Maintaining Correct Operating Conditions</i>	17
9.5. MOUNTING THE ENCLOSURE.....	18
9.5.1 <i>Mounting Surfaces and Environment</i>	18
9.5.2 <i>Detector Location</i>	19
9.6. ELECTRICAL CONNECTIONS	20
9.6.1 <i>Field Terminal Access</i>	20
9.6.2 <i>Connection Details</i>	21
9.6.3 <i>Cable Entry and Connecting</i>	21
9.6.4 <i>Conductor Preparation</i>	22
9.6.5 <i>Installation Cable Choice</i>	22
9.6.6 <i>Cable Gland</i>	23
9.6.7 <i>Refitting The Detector Cover</i>	23
10. COMMISSIONING	24
10.1. INSTALLATION VERIFICATION	24
10.2. PERFORMANCE CHECKS	25
10.3. EQUIPMENT REQUIRED FOR PERFORMANCE CHECKS	25
10.4. BUMP TEST CONDITIONS.....	26
10.5. BUMP TEST PROCEDURE	26
11. DETECTOR OPERATING SYSTEM	28
11.1. DETECTOR POWER UP	28

- 11.2. HOME SCREEN FEATURES 29
 - 11.2.1 *User Menu status* 29
- 11.3. CONFIGURATION AND CALIBRATION MENU NAVIGATION SYSTEM 30
 - 11.3.1 *Soft-Key Functions and Icons* 30
 - 11.3.2 *Quick-Nav Function* 31
 - 11.3.3 *Entering The Function Screens* 31
- 12. CALIBRATION 32**
 - 12.1. WHY CALIBRATE ? 32
 - 12.2. PREPARING FOR CALIBRATION 32
 - 12.3. ZERO CALIBRATION 33
 - 12.3.1 *Auto-Zero Calibration* 33
 - 12.3.2 *Saving the Zero Calibration Value* 34
 - 12.3.3 *Manual Zero Calibration* 34
 - 12.3.4 *Notes On Zero Calibration* 34
 - 12.4. SPAN CALIBRATION 34
 - 12.4.1 *Auto Span Calibration* 35
 - 12.4.2 *Saving Auto-Span Calibration Values* 36
 - 12.4.3 *Manual Span Calibration* 36
 - 12.4.4 *Performing a Manual Span Calibration* 36
 - 12.4.5 *Saving Manual Span Calibrations* 36
 - 12.4.6 *Isolating the Detector During Span Calibration* 36
 - 12.5. CURRENT LOOP OUTPUT CALIBRATION 37
 - 12.5.1 *Setting the 4mA Output Current* 37
 - 12.5.2 *Setting the 20mA output Current* 37
 - 12.6. DYNAMIC RESPONSE TIME TEST FUNCTION 38
 - 12.6.1 *Running the DRT Checks* 38
- 13. DETECTOR CONFIGURATION 39**
 - 13.1. SENSOR CONFIGURATIONS 39
 - 13.1.1 *Set Guard Band* 39
 - 13.1.2 *Set Measurement Full-Scale* 40
 - 13.1.3 *Detector Type* 40
 - 13.1.4 *Setting Span Gas Concentration* 41
 - 13.2. ALARM CONFIGURATION 41
 - 13.2.1 *Making Alarm Configuration Changes (Alarm 1 shown)* 42
 - 13.2.2 *Alarm 1 Trip Level* 42
 - 13.2.3 *Alarm 1 Hysteresis* 42
 - 13.2.4 *Alarm 1 Trip Direction* 43
 - 13.2.5 *Alarm 1 Normal State* 43
 - 13.2.6 *Alarm 1 Latching* 43
 - 13.2.7 *Alarm 2 Current Settings Screen* 44
 - 13.3. DIGITAL DATA CONFIGURATION 44
 - 13.3.1 *HART Setup Main Screen* 44
 - 13.3.2 *Turning HART Communications On or OFF* 44
 - 13.3.3 *HART Tag data* 45
 - 13.3.4 *HART Tag data – fixed loop mode* 45
 - 13.4. SYSTEM CONFIGURATION 45
 - 13.4.1 *SYSTEM Setup Main Screen* 45
 - 13.4.2 *Turning Detector Isolation On or OFF* 45
 - 13.4.3 *Internal Temperature Sensor* 46
 - 13.4.4 *Display Colour Invert* 46
 - 13.4.5 *Sensor Temperature Compensation* 46
 - 13.4.6 *Set Sensor Gain* 46
 - 13.4.7 *Set Menu Passcode* 47
- 14. DETECTOR MESSAGES AND WARNING STATES 47**
 - 14.1. RUNNING INFORMATION AND FAULT MESSAGES 47
 - 14.1.1 *HART Communications Active* 47

14.1.2	Detector Fault - Detector Over-Range	47
14.1.3	Detector Fault - Detector Under-Range.....	47
14.1.4	Detector Fault – Upper Operating Temperature	48
14.1.5	Detector Fault – Lower Operating Temperature	48
14.1.6	Detector Fault – Sensor Presence Failure	48
14.1.7	Detector Fault – Low Sensor Sensitivity.....	48
14.2.	FAULT LOG AND INFORMATION SCREENS	48
14.2.1	Detector Fault Log	48
14.2.2	Detector Information Screen	48
14.2.3	Resetting the Detector Life Counter	48
14.2.4	Calibration Fault	49
14.2.5	Internal Parameter Storage Fault.....	49
15.	ALARM INDICATION.....	49
15.1.1	Warn Alarm Indication	49
15.1.2	Danger Alarm Indication	49
15.1.3	Latched Alarm Indication.....	49
15.1.4	Resetting From Alarm State	49
15.1.5	Temporarily Silencing An Alarm	50
15.1.6	Clearing An Alarm State	50
16.	CONNECTING A HART FIELD COMMUNICATOR	51
17.	DETECTOR MAINTENANCE	52
17.1.	VISUAL INSPECTION.....	52
17.2.	HANDS-ON (DETAILED) INSPECTIONS	52
17.3.	GAS SENSING CELL REPLACEMENT.....	53
17.3.1	Removing the Detector Main Board	53
17.3.2	Replacing the Sensor	53
17.4.	GENERAL DETECTOR REPAIR	54
17.5.	DISPOSAL OF D-GUARD ² COMPONENTS.....	54
18.	APPENDIX A:.....	55
18.1.	OUTPUT CURRENT SIGNAL - TOTAL LOOP RESISTANCE VS POWER SUPPLY VOLTAGE	55
18.1.1	Loop Resistance - D-Guard ² With Backlight Disabled - loop at 22mA	55
18.1.2	Loop Resistance - D-Guard ² With Backlight Enabled - loop at 22mA	55
19.	APPENDIX B:	56
19.1.	RELAY BOARD AND SOUNDER OPTIONS.....	56
19.1.1	Relay Board Functionality.....	56
19.1.2	Table of Functions (identified by silk screen legend on relay board and photo annotations)	57
19.2.	RELAY BOARD CONNECTIONS	58
19.2.1	Current Loop Connection Scheme.....	58
19.2.2	Stand-Alone Connection Scheme.....	58
20.	APPENDIX C:	59
20.1.	DISABLING THE DISPLAY BACKLIGHT	59
21.	APPENDIX D:.....	60
21.1.	CHEMICAL COMPATIBILITY	60
22.	APPENDIX E:	61
22.1.	CROSS SENSITIVITY - TOXIC SENSORS	61
22.2.	CROSS SENSITIVITY - INFRA-RED SENSORS	61
23.	APPENDIX F:	62
23.1.	ENVIRONMENTAL EFFECTS ON DETECTOR PERFORMANCE	62
23.2.	TEMPERATURE	62
23.3.	PRESSURE.....	62
23.4.	HUMIDITY	62

24. APPENDIX G:	63
24.1. SYSTEM MENU MAP	63
25. APPENDIX H:	64
25.1. PERFORMANCE SPECIFICATIONS.....	64
25.1.1 <i>General Specifications</i>	64
25.1.2 <i>Methane Detector Specifications</i>	64
25.1.3 <i>Carbon Dioxide Detector Specifications</i>	65
25.1.4 <i>Electro-Chemical Detector Specifications</i>	65
25.1.5 <i>Mechanical & Environmental Specifications</i>	65

PROPRIETARY STATEMENT

GasTech Australia owns proprietary rights in the information disclosed within. By receiving this document, the recipient agrees that neither this document nor the information disclosed within nor any part shall be reproduced or transferred to other documents or used or disclosed to others for manufacturing or for any other purpose except as specifically authorised in writing by **GasTech Australia**.

COPYRIGHT NOTICE

© 2014 - All rights reserved.

Information contained in this document is protected by copyright. No part of this document may be photocopied, reproduced, or translated to another program or system without prior written authorisation from **GasTech Australia**.

TRADEMARK STATEMENT

Protected through use and/or registration in the United States and many foreign countries are the trademarks and service marks of **GasTech Australia**. The use of the ® symbol indicates registration in the United States only and the "™" is in Australia; registrations may not have been issued at present in other countries. All other product names and logos are trademarks of their respective owners.

DISCLAIMER

Under no circumstances will **GasTech Australia** be liable for any claims, losses, or damages resulting from, or arising out of, the repair of, or modification to the equipment by a party other than **GasTech Australia** or its authorised service representatives, or by operation or use of the equipment other than in accordance with the printed instructions provided by **GasTech Australia** or if the equipment has been improperly maintained or subject to neglect or accident. Any of the foregoing will void the warranty.

REVISIONS TO MANUAL

While every effort has been made to assure the accuracy and clarity of this document, **GasTech Australia** assumes no liability resulting from any omissions in this document, or from misuse of the information obtained herein. The information in this document has been carefully checked and is believed to be entirely reliable with all of the necessary information included. **GasTech Australia** reserves the right to make changes to any products described herein for the purposes of improved reliability, functionality, or design, and reserves the right to revise this document and make changes to its content as may become necessary with no obligation to notify any persons of revisions or changes.

SERVICE POLICY

GasTech Australia maintains an instrument service facility at the factory as well as authorised service facilities around the world. Should your instrument require service, you may contact us toll free at 1800 999 902 within Australia only or 61-8-6108-0000, or visit our website www.gastech.com.au for authorised service locations.

For non-warranty repairs, you will need to provide a purchase order number. If you need to set a limit to the repairs costs, state a “Not to Exceed” figure. If you need a quotation before you can authorise repair costs, so state, but understand this will incur additional costs and may delay processing of the repair.

If you wish to set a limit to the authorised repair cost, state a “not to exceed” figure. GasTech Australia’s policy is to perform all needed repairs to restore the instrument to full operating condition, including reactivation or replacement of all out-of-warranty electrochemical cells.

You may send the unit, freight prepaid, to: GasTech Australia Pty Ltd, 24 Baretta Rd, Wangara, Western Australia WA 6065. Attn.: Service Department. Enclose the copy of your contact details. Pack the instrument and all its accessories (preferably in its original packing) and any special instructions. Repairs are warranted for 90 days from the date of shipment. Sensors have individual warranties.

Always include your address, purchase order number, shipping and billing information, and a description of the defect as you perceive it. If this is the first time you are dealing directly with the factory, you will be asked to provide credit references, prepay, or authorise COD shipment.

NOTE: GasTech Australia assumes no liability for work performed by unauthorised service facilities.

WARRANTY STATEMENT

1. Consumers have the benefit of conditions and warranties implied by the Trade Practices Act 1974 (TPA) and similar provisions of State and Territory enactments and nothing in these conditions is intended to exclude, restrict or modify any statutory obligation of GASTECH AUSTRALIA PTY LTD (Company) if that cannot lawfully be effected.
2. This warranty relates only to Equipment manufactured and services supplied by the Company, its related corporations and subsidiaries. Equipment or any part thereof which is returned to the Company, transportation prepaid, within 15 months from the date of dispatch from the Company's premises or 12 months from the date of shipment to the ultimate user (whichever occurs first) and is found by the Company, after examination, to be defective in workmanship or materials, will be either repaired or replaced as determined by the Company, free of charge. The terms of this paragraph apply unless stated otherwise in this instruction manual.
3. This warranty does not apply to:
 - a) replacement or repairs which are required as a result of improper installation, misuse, maladjustment, modification or lack of routine maintenance by others;
 - b) items subject to deterioration or consumption in normal service, that is, those which must be cleaned, repaired or replaced routinely such as (but not limited to) lamps, bulbs and fuses, pump diaphragms and valves, absorbent cartridges, filter elements and batteries; or
 - c) goods, materials or parts supplied or manufactured by unrelated third parties and provided to the Purchaser at the specific request of the Purchaser and such goods, materials or parts will be repaired or replaced only to the extent of the original supplier's warranty.
4. Should the Company be liable for breach of a condition or warranty (other than the pursuant to section 69 of the TPA) implied by Division 2 of Part V of the Act (other than that implied by section 69 of the TPA) the liability of the Company for such breach shall, subject to section 68A(2) of the TPA, be limited to one of the following as determined by the Company.
 - a) the replacement of the Equipment or the supply of equivalent Equipment;
 - b) the payment of the cost of replacing the Equipment or of acquiring equivalent Equipment.
5. Subject to Clauses 2 and 4 and any legislation to the contrary:
 - a) representatives and agreements not expressly contained herein shall not be binding upon the Company as conditions, warranties or representations; all such conditions, warranties, and representations on the part of the Company, whether express or implied, statutory or otherwise, whether collateral or antecedent or otherwise are hereby expressly negated and excluded;
 - b) the Company shall be under no liability to the Purchaser for any loss (including but not limited to loss of profits and consequential loss) or for damage to persons or property or for death or injury caused by any act or omission (including negligent acts or omissions) of the Company or the Company's agents, wherever occurring, arising from the subject matter of this agreement;
 - c) the Purchaser shall indemnify the Company against any claims made against the Company by any third party in respect of any such loss, damage, death or injury as is set out in sub-paragraph b) hereof; the Purchaser further agrees to indemnify the Company against all losses and expenses which the Company may suffer or incur due to the failure of the Purchaser fully to observe its obligations under this contract; and
 - d) no warranty is given and no responsibility is accepted by the Company to ensure the Equipment supplied complies with any statutory requirements relating to the marketing of goods. Compliance with such legislation shall be the sole responsibility of the Purchaser.
 - e) the Company specifically denies any liability for the overall performance of any plant or the results of any process with which the Equipment is integrated.

Manual Conventions

D-Guard² is designed to detect, depending upon which sensor type is fitted, flammable gases and vapours, oxygen concentration or toxic gases. The detector is intended to signal one or more warnings before gas concentrations reach dangerous or harmful levels.

In order to ensure that the detector's intended function will operate as designed, it is essential that the information and instructions presented in this manual are read and understood prior to installing, using or maintaining the equipment. In particular, a thorough understanding of the information relating to configuration, operation, calibration, and maintenance is essential before using D-Guard².

To aid with the process of bringing attention to key points, graphical notices are used in this manual. These notices are graded based upon the consequence of ignoring or incorrectly applying the information given.



Warning.

Significant risk to health and safety with the possibility of serious injury or death.



Caution.

Possibility of unsafe operation of D-Guard² and connected equipment.
Warranty of D-Guard² and connected equipment may be invalidated.



Note.

Additional information is provided to assist with understanding of detector operation, configuration, calibration or maintenance.

1. Warnings, Cautions and Notes

For safety reasons, D-Guard² must be installed, operated and serviced only by competent and appropriately trained personnel. Reading and understand this instruction manual completely is essential before installing, operating or servicing this equipment. Failure to install or operate this instrument in accordance with instructions contained in this manual may result in invalidation of the conditions of warranty and additionally create hazardous operating conditions.

2. Limitations of Use

D-Guard²G, D-Guard²R and D-Guard²S Detectors:-



Can NOT be used in Group I hazardous area applications.



Can NOT be used in Group IIC hazardous area applications.



Can NOT be used in Group IIB hazardous area applications.



Can be used in conjunction with other equipment as part of a safety instrumented system for the purposes of risk reduction.



The detector is NOT designed to be used as the sole means of ensuring safety to personnel or equipment.



Must not be used in an oxygen enriched atmosphere.



Must not be modified in any manner*. As supplied, the unit is constructed in accordance with, and is compliant with the quality and performance standards against which it has been designed and tested. Modification to its construction will invalidate the product's warranty.



Is not on-site repairable and contains no user serviceable parts (sensors and filter excepted).

3. Product Markings

The D-Guard²G, D-Guard²R and D-Guard²S Gas detectors are designed for use in general purpose non-certified applications only. Their suitability for use in any particular application depends on the product variant and the sensor type fitted.

The detectors carry the following information as part of its serial number identification label:



These markings provide information identifying the gas type, serial number and its IP rating.

Label Details (model number and IP rating) will vary depending upon the model type.

65-1080G-xxx: Base model. IP66/67/68.

65-1080R-xxx: Relay option fitted. IP66/67/68.

65-1080S-xxx, Relay and Sounder/Strobe fitted. IP65.

4. RECEIVING AND STORAGE

4.1. Receiving

All possible precautions are taken to protect the equipment against damage or losses during shipment to our customers, however before accepting delivery, it is strongly recommended that a check of all received items is made against the packing list or billing of lading. If there is a shortage or evidence of physical damage, notify GasTech Australia immediately.

Notify GasTech Australia within 7 days (maximum) in case of shortage or discrepancies, according to the packing list. This will assist in a speedy resolution to problems. Please keep a record of all claims and correspondence. Where possible, taking and supplying photographs is advantageous.

Where practicable do not remove protective covers prior to installation unless there are indications of damage that necessitate closer inspection. Packaging that has been opened for inspection and inventory logging should be carefully repacked to ensure protection of contents or else the parts should be packaged and stored in a safe place. Examine all shipping boxes, and protective packaging for items attached to them, especially if the wrapping are to be discarded.

4.2. Inspection

Equipment that is found to be damaged or appears to have been modified in any manner must not be used. Please contact GasTech Australia if the equipment is suspected to be different than that ordered or if it does not match the published specifications.

4.3. Storage

Where equipment is not going to be installed immediately, proper storage is important to ensure protection against damage. Damage incurred during storage could render the equipment non-functional.



Electro-Chemical gas sensing cells (used in this equipment), have a maximum 'shelf' life of 6 months from the date of shipment by GasTech Australia. If equipment is stored for periods longer than this, the performance of the gas sensing cell cannot be guaranteed by GasTech Australia.

All equipment should be stored indoors in a cool dry location, protected from adverse environmental elements. If storing at ground level, ensure that the storage area is not an area where water will collect.

5. GasTech Australia Contact Details

Head Office

24, Baretta Rd,
Wangara, Western Australia 6065

Int. Phone: +61 8 6108 0000
Int. Fax: +61 8 9408 1868
Email: info@gastech.com.au

6. GENERAL SAFETY PRACTICES

6.1. Relevant Personnel

Ensure all personnel directly responsible or involved with installation, operation and maintenance of the equipment make reference to this manual in conjunction with any relevant risk assessments conducted to identify and minimise potential hazards.

6.2. Safety Communication

All safety instructions, usage conditions and restrictions given within this manual must be communicated to all users. These requirements are necessary to identify and control potential risk associated with possible misuse or incorrect application of this piece of equipment. In the event of damage or malfunction to the detector that results in the potential to compromise the health and safety of any personnel, the owner/operator should notify the manufacturer immediately.

6.3. Safe Use of Equipment

Equipment as supplied has been manufactured within the controls of relevant International and/or Australian Standards and state legislative requirements. Equipment identified within this manual has been designed for a specific purpose, therefore any modification or damage to it must be reported to the manufacturer to allow for repair or replacement.

The instructions within this manual must be observed as an aid towards achieving maximum safety during operation.

6.4. Modifications to Equipment



Modifications to the design or construction of this equipment is not permitted under the conditions of its warranty.

6.5. Equipment Knowledge

Experience in the use of, and a technical understanding of this equipment is essential for its safe installation, operation, maintenance and removal from an application. If in doubt, seek advice from a supervisor and/or contact GasTech Australia immediately.

Mechanical, electrical installation and maintenance of plant and equipment, must only be carried out by appropriately, trained, qualified and competent personnel.

7. INTRODUCTION

7.1. Purpose and Contents Of This Manual

This manual contains installation, operating and maintenance instructions for the GasTech Australia D-Guard²R and D-Guard²S current loop / 3 wire powered, Smart Gas Detectors. Users of this equipment must read and understand the contents of this manual in order to ensure safe use and optimum performance from the product.

7.2. Product Identification and Type

The products are named D-Guard²R and D-Guard²S. The products classification are either as loop-powered toxic and flammable gas detectors (no relays or sounder), or as 3-wire connected toxic and flammable gas detectors when fitted with either the relay option (R version) or both relay and sounder (S version).

Individual detectors are identified by a unique serial number located on the product identification plate fixed to the side of the enclosure. Reference to this label is important to correctly identify the product build and gas type. Detectors must only be used in applications for which they are compatible.

D-Guard²R and D-Guard²S are non-Ex certified detectors and MUST NOT be used in applications requiring explosion protected Ex certified equipment.

The gas type and range detectable by the unit are set by the combination of an appropriate sensor type being installed and by configuration via the set-up menus. **However** - for the product to remain compliant with its warranty, end users are **NOT** permitted to change the gas type measured by substitution of sensor type. This is only permitted to be carried out by GasTech Australia or an approved GasTech Australia representative.



If changes to the gas sensor type are carried out by the end user, product warranty will be invalidated.



End users may change the gas measurement **range and displayed gas name** via the configuration menus and / or HART communications, however GasTech Australia will not accept responsibility for, nor accept liability for damage or injury caused by instruments rendered unsuitable for any particular application following such changes. The facility for configuring the detector from within its operating system is primarily intended for use by GasTech appointed distributors and service teams.

The following table specifies the default 'as-supplied' product variations.

Gas Type	Full Scale Range	GasTech Australia Part No.		
		Base Models	Optional Relays Fitted	Relays and sounder/strobe fitted
Ammonia	0 - 100ppm	65-1080G-NH3	65-1080R-NH3	65-1080S-NH3
Carbon Monoxide	0 - 1000ppm	65-1080G-CO	65-1080R-CO	65-1080S-CO
Chlorine	0 - 10ppm	65-1080G-CL2	65-1080R-CL2	65-1080S-CL2
Ethylene Oxide	0 - 20ppm	65-1080G-ETO	65-1080R-ETO	65-1080S-ETO
Fluorine	0 - 1ppm	65-1080G-F2	65-1080R-F2	65-1080S-F2
Hydrogen Chloride	0 - 100ppm	65-1080G-HCL	65-1080R-HCL	65-1080S-HCL
Hydrogen Cyanide	0 - 50ppm	65-1080G-HCN	65-1080R-HCN	65-1080S-HCN
Hydrogen Sulphide	0 - 200ppm	65-1080G-H2S	65-1080R-H2S	65-1080S-H2S
Nitrogen Dioxide	0 - 10ppm	65-1080G-NO2	65-1080R-NO2	65-1080S-NO2
Nitric Oxide	0 - 100ppm	65-1080G-NO	65-1080R-NO	65-1080S-NO
Ozone	0 - 2ppm	65-1080G-O3	65-1080R-O3	65-1080S-O3
Phosphine	0 - 1ppm	65-1080G-PH3	65-1080R-PH3	65-1080S-PH3
Sulphur Dioxide	0 - 10ppm	65-1080G-SO2	65-1080R-SO2	65-1080S-SO2
Oxygen	0 - 25% volume	65-1080G-O2	65-1080R-O2	65-1080S-O2
Methane	0 - 5% v/v	65-1080G-LEL	65-1080R-LEL	65-1080S-LEL
Methane	0 - 100% v/v / LEL	65-1080G-CH4	65-1080R-CH4	65-1080S-CH4
Carbon Dioxide	0 - 1.5% v/v	65-1080G-CO2	65-1080R-CO2	65-1080S-CO2
Client Specified*	xxx = gas type/range	65-1080G-xxx	65-1080R-xxx	65-1080S-xxx
	*Toxic gas types only			

Table 1: Standard/Custom Gas Types and Ranges covered by the D-Guard²G, D-Guard²R and D-Guard²S ranges.

7.3. Contents Of D-Guard-2 Package

The shipment package for an individual D-Guard² should contain the following components:

- Gas Detector assembly.
- User Manual.
- Combined enclosure / splashguard key and calibration magnet.
- Manufacturing Quality certificate.

If the received package is incomplete, please contact GasTech Australia or the distributor that supplied the product. **Refer to Section 4** for unpacking and storage information.



8. PRODUCT DESCRIPTION

8.1. Product Function

The D-Guard² smart Gas detector's function is to detect the presence of gas (or reduction in oxygen concentration) in the environment immediately surrounding it. Such gases may be toxic, flammable or asphyxiant, where concentrations may exceed safe exposure limits for occupants or combust in the presence of ignition sources. The D-Guard² detector range is designed to connect to other equipment or systems that are responsible for activating ventilation and/or sounding alarms to mitigate the risks associated with the presence of increased concentrations of gases or low levels of breathable oxygen.

8.2. Description Of Operation

The D-Guard² smart gas detectors are designed to sense gases that enter them via the process of natural diffusion through the gas entry port.

The sensor type used within the D-Guard² to detect the gas is dependent upon the specific characteristics of the gas needing to be monitored. If the gases to be monitored pose a risk of being toxic, then a D-Guard² with electro-chemical type cells must be used. With the exception of hydrogen, if the reason for monitoring gas is due to the risk of ignition, then a D-Guard² fitted with Infra-Red sensors should be used. For detection of hydrogen, a D-Guard² with an electro-chemical cell should be used. For monitoring oxygen levels for depletion, a D-Guard² with an oxygen sensor must be used.

In any environment, gases released into an open space will spread-out (diffuse) to equally occupy the volume of space available. The diffusion of gases occurs due to mechanisms such as natural or forced air currents as well as molecular collisions.

Whether the space into which gas is released is totally empty of any gas molecules, or already contains gas molecules (e.g. air), the molar concentration (a measure of the actual number of gas molecules) or the volumetric concentration (a measure of relative amounts of each gas component in a mixture) of a gas at any given location and time will relate to its concentration at the point of release, the volume of space into which it expands and influences such as ventilation that affect the rate at which diffusion occurs. In most cases, over a long enough time, the concentration of gas anywhere within the space will have equal concentration. However, in areas with enclosed spaces with poor ventilation, gas may 'pool' in higher concentrations if the rate of gas leakage into the space is greater than the rate of diffusion out of it. Pooling can occur in roof spaces for gases that are less dense than air or in pits and tunnels for gases that are more dense than air.

The various diffusion processes are the mechanism by which gas enters the D-Guard² in order to be detected. Gas molecules will diffuse through the gas-permeable waterproof membrane and into the sensor body, where they react with specific sensor mechanisms to produce signals proportional to the gas concentration.

For toxic gases entering electro-chemical sensors, an electrical current proportional to concentration will be produced. For flammable gas molecules entering an infra-red sensor, infra-red energy will be absorbed proportionate to gas concentration. This absorption is processed to produce a concentration related signal. Signals from the various sensor types feed into the detectors electronics and signal processing software where they are converted to scaled values and used for display indication, concentration and alarm signalling.

D-Guard² signals gas concentration to remotely connected equipment via its two power supply connections. It does this by varying the amount of current it draws from the power supply in direct proportion to the gas concentration measured. This is generally referred to as 'current loop signalling' and commonly uses 4mA to represent zero gas conditions and 20mA to indicate full scale. D-guard² can also signal gas concentrations, along with other data using a digital communications system called 'HART' (Highway Addressable Remote Transducer/Transmitter). This digital signal is super-imposed onto the current loop 4-20mA signal. Additionally, D-Guard² can (optionally) provide volt-free relay contacts that can be programmed to respond at user-set gas concentrations. Gas concentration values and other information is also presented on the display for localised reading. Sensor operating errors are also signalled via a current loop level above or below the normal 4-20mA range.

9. INSTALLATION

9.1. Installation Considerations

The D-Guard² Toxic Gas detector would generally be part of a larger system and be connected to other components or equipment within it. These other pieces of equipment would generally provide the function of signal acquisition, decision making, shutdown, control and indication (PLC's, fan controls, beacons, sirens, SCADA systems etc.). D-Guard² can also be used as a standalone instrument as part of a 'mini system' using alarm type devices connected directly to its relay terminals.

Whichever type of system D-Guard² is intended to be used in, before the detector can be installed, there are a number of things that need to be considered to prevent incorrect or unsafe operation of both the detector and the system into which it is installed. Along with relevant competence, and an understanding of the target application, the following points should be considered:-



Ensure that the information provided in sections 1 to 6 is fully understood.

*It is extremely important that the **limitations** and **restrictions for use** of the detector are understood in order to prevent the creation of hazardous situations and increased risk of dangerous events occurring . If in doubt as to the nature of these limitations/restrictions, or their implication, consult a competent authority such as a supervisor or GasTech Australia applications engineer.*



Ensure that the information in sections 11 to 19, plus Appendix A are understood.

*It is extremely important that the **functionality** of the detector is fully understood in order to reduce the likelihood of creating hazardous situations and risks due to a malfunctioning detector or gas monitoring system. If in doubt as to the functionality of the detector, or the implications of incorrect use, consult a competent authority such as a supervisor or GasTech Australia applications engineer.*



Ensure that the application into which the detector is to be installed is correctly understood.

Any system intended to mitigate the risk of injury needs to be properly designed and implemented. Such a system must be the result of structured risk analysis with the outcomes used to help define the safety system requirements. Such risk assessments will take into considerations the nature of the application along with its processes and likely hazards. The safety system requirements, in turn, will guide the choice of instrumentation, logic solvers and actuators needed to implement the system. Understanding the required functionality of the system will ensure proper selection and safe deployment of equipment.



Ensure that the detector will properly perform the required functions within the system design.

It is important to understand how the detector will interact with other equipment within a system. For safe and reliable use, it is crucial that neither the detector or other system components signalling be compromised by incompatibilities between equipment.

9.2. General Installation Practices

Before starting the installation process, read this operational manual thoroughly, making particular note to any aspects that could affect the reliability or accuracy of D-Guard². It is essential that the operational specifications for the instrument are understood in relation to compatibility with the rest of the system.

Refer to Appendix C for information regarding sensor basics, chemical compatibility and cross-sensitivity.

- D-Guard² should be installed in a location allowing easy access for repairs, adjustments and calibration. The mounting position must allow visibility of the identification plate.
- Mount the instrument in a position that will minimise the risk of mechanical damage.
- Ensure that the gas entry port is clear of obstruction which would prevent the passage of gas into the internal detector cell.
- Prevent water and dust accumulation from affecting operation by mounting the sensor unit with the gas entry port pointing forwards or downward. Do not install the instrument with the gas entry port facing upwards as this may allow the collection of water or dust to prevent gas entering the sensor.
- Do not leave the splash-guard unfitted as this will allow water and dust to collect directly on the sensor surface filter.
- It is important to ensure that any cable entry points to the enclosure are watertight by properly tightening up the cable entry grip.
- If cable glands are to be substituted, they must be replaced by types suitable compatible types and must be both IP66 and IP68 ingress protected to maintain the detectors overall IP rating.

9.3. Detector Dimensions and Mounting Orientation



Ideal position
(Recommended)

Operationally acceptable positions (although the display is difficult to read)



Do **NOT** Mount this way

9.4. Installation Considerations.

The connections between D-Guard² and other interconnected equipment must be compatible in terms of voltages, power capabilities and input resistances if the detector is to function correctly.

Particular attention should be paid to the minimum and maximum voltage output from any power source since the ability for the detector to properly signal measured gas concentrations will depend on correctly chosen power supplies.

9.4.1 Power supplies

If the power supply voltage is too great, there is a risk of damaging the detector. Power supply voltages that are too low at the detector input terminals may prevent the full 3.3mA – 22mA signalling range being available at the system controller input.

9.4.2 Typical Connection to a power supply and controller

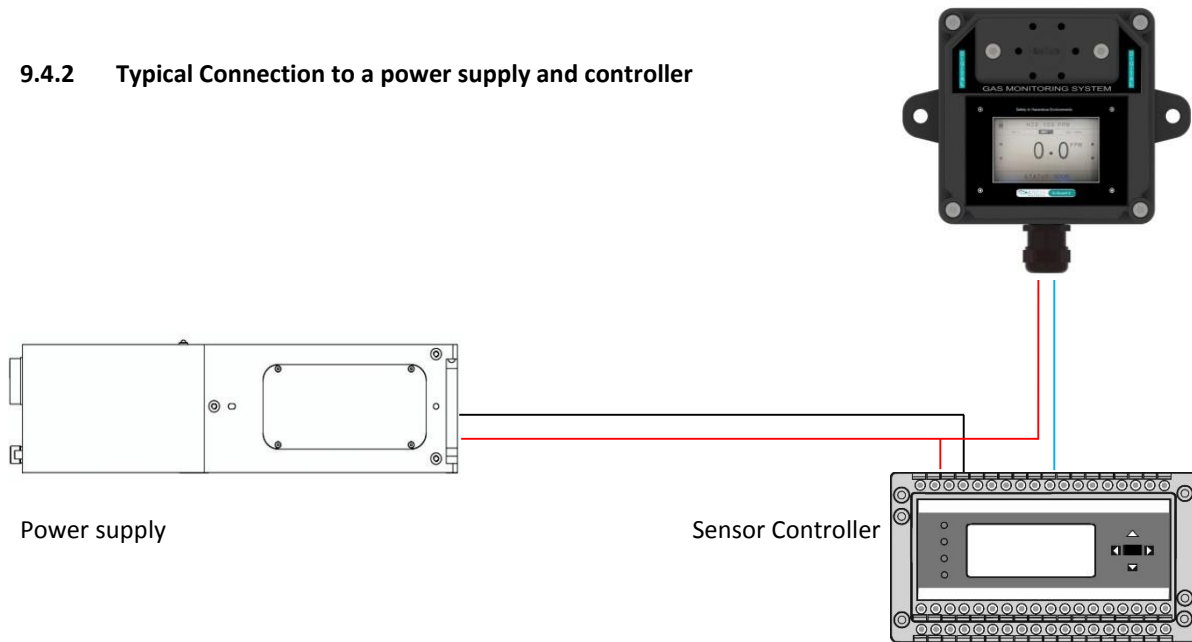

9.4.3 Maintaining Correct Operating Conditions.

When handling the D-Guard² during installation, great care must be taken to not damage any part of the system components, since this may compromise its functionality.

Damage caused by mishandling or by connection to incompatible equipment could render inoperative, those aspects of the detector that product correct operation and safety rely on.

If any damage is evident to any part of the detector electronics or enclosure system, it must not be used.

If such damage is present, advice from GasTech Australia should be sought to remedy the problem before proceeding.

9.5. Mounting the Enclosure

The D-Guard² enclosure provides two mounting feet that are external to the enclosure. These are located to the left and right of the instrument and can accommodate screw/bolt sizes up to M8.

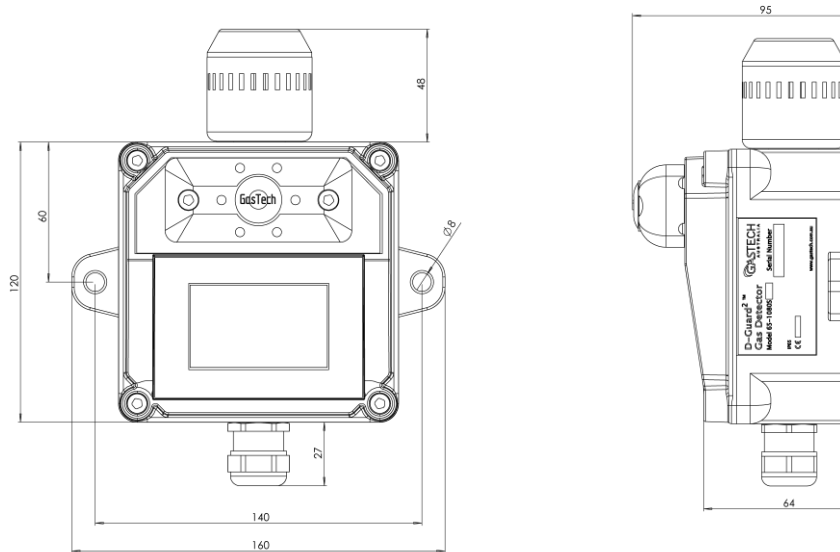

9.5.1 Mounting Surfaces and Environment

The surface that the detectors are to be mounted to should be as flat as possible to provide stable, secure fixing. If the mounting surfaces are uneven and mounting screws are over-tightened, it is possible to apply undesirable stresses to the enclosure mounting points. Ingress rating may also be affected if the enclosure is deformed by mounting to an uneven surface.

Do not mount the detector to a surface using adhesive materials as this will not allow easy removal if necessary. Additionally, the use of adhesives on the enclosure will void the product warranty. Adhesive fumes may also cause degradation to the gas sensing cell, leading to premature failure.

Ensure that any surface coverings such as paint do not emit vapours. Many paints can release VOC's (Volatile Organic Compounds) that, if sufficient in concentration can react within the electro-chemical gas sensing cell. This reaction can cause errors in reading, shorten the life of the cell or cause cell damage.

If the detectors are to be mounted into a newly built and painted area, it is strongly advised that paints be allowed to dry thoroughly before installing the detectors.

9.5.2 Detector Location

Although over time, gas released into a space will expand to uniformly fill it with equal concentration, in many practical applications, there exists the possibility of pooling due to areas that have little or no ventilation or natural movement of air. For these locations higher than average concentrations of any gases present may exist since natural diffusion could well be a slower process compared to the rate at which gas is entering the area. In working environments where there is a likelihood of these situations occurring, proper consideration to the location of gas detection instruments is important.

The specifics as to what constitutes the ideal location for gas detectors are strongly dictated by the actual physical makeup of the environment. Considerations could be for example: - likely points of release, location of personnel in relation to points of release, ventilation characteristics, temperature, volume of space in and around personnel (open or confined space) and maximum time durations for exposure to any released gases.

Knowing the characteristics of the gases to be monitored can assist in deciding on optimal locations. Permissible exposure levels are covered by various health and safety standards and are not reproduced in this manual.

A characteristic of significant interest is the buoyancy of the gas in air, essentially whether it is more or less dense than air. Knowing this can provide some indication of areas of possible pooling or areas near a point of release that leaked gas will initially move towards.

Gas	Density (kg/m ³) @ STP 101.3kPa/15°C	Relative Density (Air = 1.0)	Heavier or Lighter Than Air
Air	1.225	1.0	-
Ammonia	0.7289	0.595	Lighter
Carbon Monoxide	1.1849	0.967	Lighter
Chlorine	3.04	2.480	Heavier
Ethylene Oxide	1.8375 (101.3kPa / 20°C)	1.52	Heavier
Fluorine	1.6074	1.312	Heavier
Hydrogen	0.0852	0.0695	Lighter
Hydrogen Chloride	1.56	1.274	Heavier
Hydrogen Cyanide	1.15	0.94	Lighter
Hydrogen Sulphide	1.4534	1.186	Heavier
Nitrogen Dioxide	3.21	2.62	Heavier
Nitric Oxide	1.3402 (101.3kPa / 0°C)	1.094	Heavier
Ozone	2.154 (101.3kPa / 0°C)	1.758	Heavier
Phosphine	1.45	1.184	Heavier
Sulphur Dioxide	2.7633	2.256	Heavier
Oxygen	1.354	1.105	Heavier
Methane	0.6797	0.555	Lighter
Carbon Dioxide	1.8714	1.53	Heavier

Table 2: Absolute and Relative Densities of Common Gases Referenced Against Air.

* Absolute densities are given at STP 101.3kPa / 15°C unless otherwise noted

9.6. Electrical Connections

D-Guard² requires only two connections to be made in order for it to function. These two connections convey input power and return the process related current signal.

The functions of both power supply and signalling are therefore carried out over the same pair of wires.

For D-Guard² variants with HART communications, the digital signal also uses the same two wire connections.

9.6.1 Field Terminal Access

Access to the D-Guard² field terminals involves opening the enclosure, which is achieved by undoing the four corner lid screws using a 4mm Allen Key.

The main electronics are fixed to the front panel (Lid) of the enclosure and the input power and loop-return connection is located to the bottom right of the circuit board as viewed from the rear of the board (shown in the diagram below).



Removing the lid of the enclosure, exposes a number of critical system elements that must be treated with care in order to maintain the operational integrity of the instrument.

- Avoid touching the circuit board with hands or tools.
- Avoid disturbing the sealing gasket that sits in the groove along the edge of the base section of the enclosure. This seal is essential for correct ingress protection.

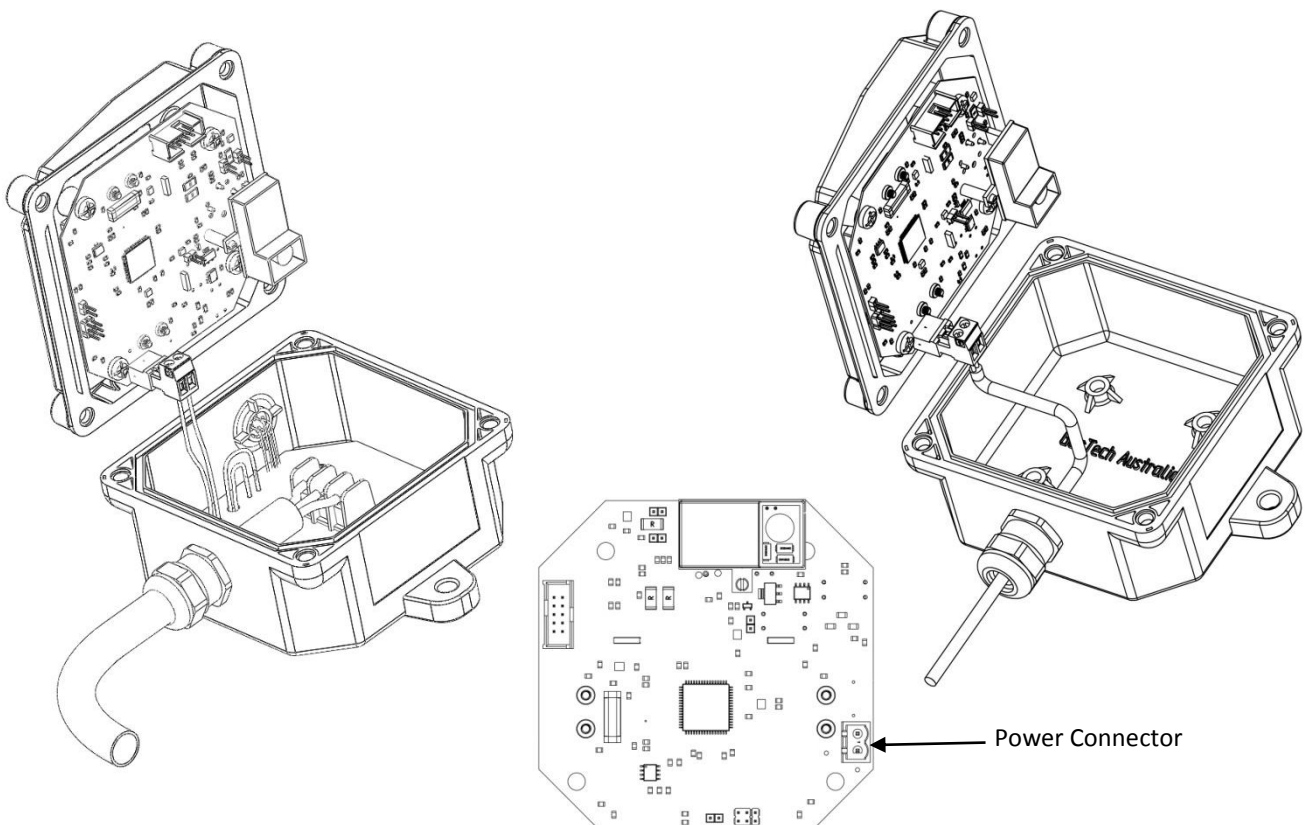

Depending on the build of the instrument, connection to the main system board can be either direct to the power connector or via a terminal board mounted in the base section of the enclosure. Connection directly to the system board connector, is suitable for lighter duty cables (single or dual screened, twisted pair type cables). See section 8.6.5 for cable types.

9.6.2 Connection Details

Connection Directly To System PCB:

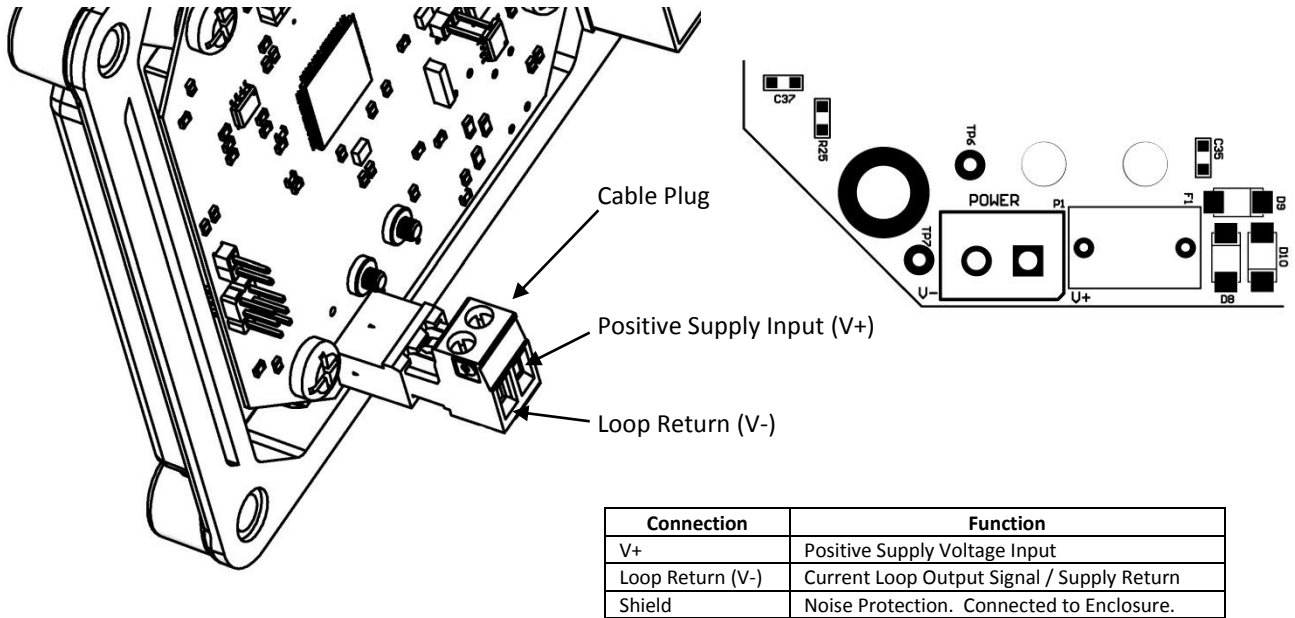

Connection To Terminal Board

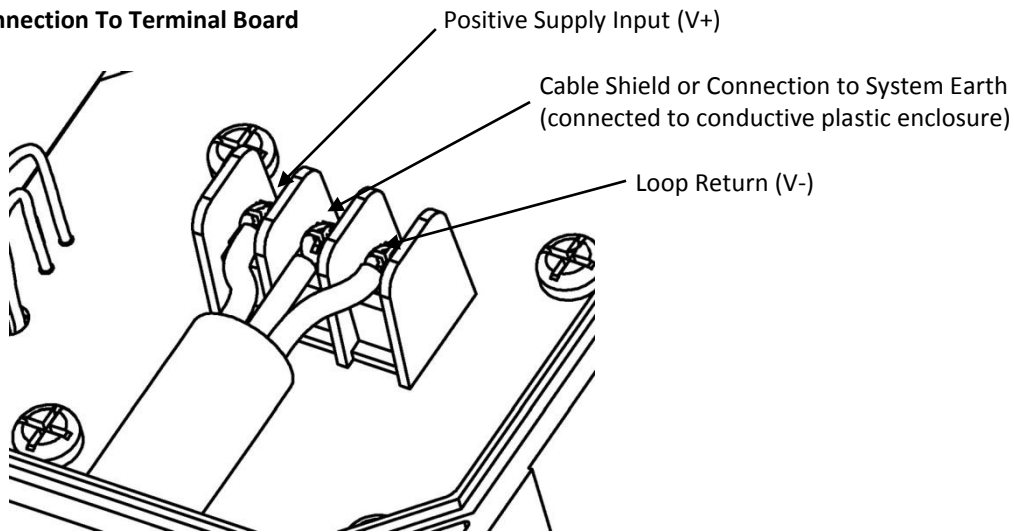

9.6.3 Cable Entry and Connecting

The power cable must enter the base section of the enclosure via the cable gland.
 For connections direct to the main system board, pass the cable into the enclosure through the gland and allow enough free cable length to prevent 'pulling' on the power connector when the lid is removed / replaced.
 Once the cable is positioned as required, tighten the cable gland nut to hold the cable in place and create the waterproof seal.
 When connecting direct to the main system board, connections are first made to the power plug (supplied with the instrument), and the plug is then engaged into the power socket as shown above. The plug and socket are keyed for correct alignment.
 Connection to the barrier type terminals is as shown above. Connections between the terminal board and the main system board are already in place as part of the detector assembly and require no user attention.

9.6.4 Conductor Preparation

The ends of the conductors to be fitted into the power plug, must be properly terminated with suitable ferules (bootlace or flat-blade). The supplied power plug will accept terminations with a cross sectional area between **0.2mm²** and **2.5mm²**.

It is not advisable to simply strip the conductors and place the un-terminated ends into the power plug, as this is likely to fail over time.

Using striped and solder tinned conductor ends is also strongly discouraged since solder will 'cold-creeps' and compresses over time resulting in loose connections.

Connection to the barrier terminal connection strip is most reliable when using fork or ring type crimp terminals. The barrier connector's cable clamp can accommodate conductors with a cross sectional range of **0.33mm²** to **3.3mm²**. Ring / fork terminals should have a hole / slot size greater than 3.7mm to allow the terminal screw to pass through them freely.

9.6.5 Installation Cable Choice

For correct and reliable operation, electrical connections between the D-Guard² detector and the rest of the system must only be made using appropriate cable. The choice of cable will depend on application and general adherence to the wiring regulations appropriate for the installation.

The presence of electrical noise in an installation can cause instability of the instrument readings if not considered and removed by proper wiring methods.

Instability of this type generally shows as the measured gas value changing fairly rapidly in a random way.

Electrical noise may coincide with a piece of equipment (e.g. variable speed drive) switching on, off or as its speed is controlled.

The size of the apparent changes in gas reading due to electrical noise could be sufficiently large to cause the detector to enter an alarm state, especially for instruments with low alarm ranges such as 1ppm or less.

With proper cable shielding, noise can be dramatically reduced or eliminated, allowing the response from the detector to properly represent the ambient gas conditions. The normal detector response is steady with only small, slow variations in readings. If there are no background levels of gas present, then the readings should be stable at or near zero with no significant variations.

The actual configuration of the shielding will depend upon the specific application, but as a rule, the cable shield should be connected to earth (system ground reference point) at either the detector **or** the controller, but not at both. In most typical applications, the shield will be connected to an appropriate ground point at the controller end.

The D-Guard² detector has provision for connecting the cable shield using the middle screw terminal on the terminal board barrier terminal connector. This connection point is electrically connected to the detector enclosure which has conductive elements embedded within the plastic material.



The electrical conductivity of the enclosure is low and may under certain mounting conditions contribute to the creation of noise loops if the cable screen is connected at the controller side of the installation and also to the barrier terminal middle shield terminal. This may arise if the detector is mounted on a metal plate which is also connected to the system ground.

If connecting the screen to both the controller side and the shield terminal of the detector, the detector enclosure may need to be isolated from system ground.

Typical suitable cable types for installing D-Guard² would be:- Type 25 (e.g. Olex MCFR58AA004) OR twin twisted pair data cable such as Belden type 9829.

9.6.6 Cable Gland

The cable gland fitted to the D-Guard² detectors is a 20mm type rated to IP66 and IP68. The gland rating is matched to the enclosure in terms of protection against moisture ingress. In order to maintain the integrity of the detector housing, it is vital that the cable gland is used properly. Proper use includes, feeding only a single cable through it and that the cable sheath is at least 5.5mm in diameter. The gland nut must be fully tightened to form a seal between the gland's sealing sleeve and the cable sheath. Multiple cable feeds through the gland and/or improper tightening of the gland nut can result in water ingress into the enclosure. The presence of water within the enclosure may cause extensive damage to the electronics, resulting in a dangerous system failure and voiding of product warranty.

9.6.7 Refitting The Detector Cover

Once the electrical connections have been made to the instrument, the front cover (lid) must be refitted correctly to maintain the IP66/68 ingress protection rating.

The enclosure base is fitted with a sealing gasket that is located in a groove that runs around the perimeter of the opening.

Before replacing the cover, check that the gasket is present and seated correctly in the groove. The gasket must not be twisted, stretched or out of the groove at any point.

If the lid is replaced onto a faulty or misaligned gasket, the ingress protection is likely to be compromised with resulting instrument failure possible.

Align the cover with the base section and slowly tighten up the four corner screws.



Initially tighten the four screws loosely so the lid just grips the gasket in the enclosure base. Proceed to tighten each of the four screws by just one or two turns at a time, continually moving from one screw to another until all screws are fully tight. Doing this will help to keep the gasket flat and evenly positioned as the lid is tightened up. If each screw is tightened individually, uneven pressure may be applied to the gasket resulting in a less than perfect seal.

10. Commissioning

Once D-Guard-2 has been mounted and electrically connected, it must be commissioned.

Commissioning of the monitoring system to which D-Guard-2 is connected is beyond the scope of this manual since specific methods will depend upon the details of the installation. There are nonetheless, common considerations to make in the processes of testing newly installed gas detectors. The following is a recommended sequence of checks to assist in ensuring correct operation of D-Guard-2.



Commissioning must be carried out by suitably trained personnel operating under permitted site conditions. Incorrectly commissioned detectors could cause the monitoring system to become non-operational in its intended manner, resulting in potentially harmful situations. Performing commissioning using non-approved or site inappropriate equipment could create a hazard situation and increase the risk of injury.

10.1. Installation Verification

The specifics of performing the steps listed below will depend on the nature of the installation and any /all conditions governing the installation site or area. Before each of the steps are followed, it is essential to ensure that appropriate measures and precautions have been taken to reduce the likelihood of a hazardous situation being created and that the risk of triggering a dangerous event is not increased (e.g. ignition of combustible gas). It may not be possible or practical to carry out every one of the steps given below.



If in doubt regarding the methods of commissioning, or possible outcomes of carrying out commissioning steps, consult an appropriate supervisor for advice or training. Do not conduct commissioning on a system unless fully competent to do so and only with the knowledge that it is safe to do so.

- Ensure that power to the detector is isolated at the controller side of the installation.
- Visually check that detector mounting conforms to information given in this manual.
- Check that all electrical connections within the detector(s) are correct per this manual.
- Conductors should be marked and coded at each end for easy identification.
- Check that the power supply feeding the detector is of an appropriate type and that it is matched to the detector's requirements.
- Switch on the system power and check that the supply voltage at the detector power terminals meets the requirements given in the detector specification table at the end of this manual. Newly powered up detectors can draw full scale current for the first few minutes of operation whilst the gas sensing cell settles. This will present a greater than normal load demand on the power supply. An under-rated power supply and/or poor cabling can create voltage drops between the power supply and the detector. This situation is made worse when numerous detectors share the same cable run.
- Once powered (power supplies correct and stable), allow the system to settle for at least 1 hour.
- The detector display should be on. Displayed information includes gas type and range, status messages and gas reading. The gas reading should be showing either a stable zero or a value representative of the sensor cell as it stabilises. Initially this may be a full scale or negative reading. The status message may be indicating a sensor low fault, or over-scale message. These are normal conditions that can be expected for the first few minutes after power up. At the end of the 1 hour period however, the detector display must be indicating zero or close to zero and status messages must indicate that there are no faults or alarms.

- Observe the system readings derived from the detector's current loop output signal and check that they are as expected. For instruments other than those monitoring oxygen, the current loop signal level should be near 4.00mA (no background gas present). Oxygen monitors will have a baseline signal current at approximately 17.37mA to 17.38mA. If the controller system has measurement scaling applied to the detector's current loop signal, then the 4mA baseline current would represent 0.00 for all detector types except oxygen. For oxygen monitors, the readings should equate to around 20.9% volume.
- Check that the detector readings are stable and representative of expected surrounding gas concentrations.
- If problems are observed during the commissioning process, they must be addressed before the installation can be completed and the detector put into service.

10.2. Performance Checks

After the installation has been verified and the system has been powered up for at least 1 hour (ideally several hours allow the sensors to fully settle), a 'bump' test to verify the detector's response to target gas must be carried out.



Bump-testing must only be carried out by suitably trained personnel under permitted site conditions. Carrying out bump-testing using non-approved or site inappropriate equipment could create a hazard situation and increase the risk of injury. All equipment must be approved for use at the site / area where the detector is installed and must be used only as instructed in its operational manual by appropriately trained personnel.



Bump test procedures involve the use of toxic gases. The gas concentrations used for test and calibration purposes are considered non-harmful over the time period for which testing is likely to occur. It is however, the responsibility of the personnel carrying out commissioning to ensure that all relevant occupational health and safety regulations are observed and that proper gas handling procedures are followed.

These tests must only be performed by suitably trained personnel. GasTech Australia makes the assumption that personnel carrying out any procedure given in this manual are fully competent in the handling and use of toxic gases, gas cylinders, regulators and piping/hoses.

10.3. Equipment Required For Performance Checks

- Purge Gas: 100%v/v nitrogen or clean instrument air.
- Target Gas: To match detector type. Optimally balanced in air or with an instrument air content.
- Purge gas and target gas must be contained in an appropriate cylinder fitted with a suitable regulator providing a flow rate of between 0.5 to 1.0 litres/minute.
- Appropriate hoses must be fitted to the cylinder, which may include PTFE types for certain 'sticky' gas types such as chlorine, ammonia, nitrogen dioxide etc.
- Target gas concentration must not be greater than the instrument's full scale reading
- Target gas minimum concentration must not be less than 25% of the detector's full scale reading.
- Service Tool.
- Detector calibration plug.
- Suitably approved digital multimeter with a traceable calibration.

10.4. Bump Test Conditions



Bump tests must be carried out with the detector operating within its specified limits. Operating the detector outside of its limits could cause performance problems or functional failure.

10.5. Bump Test Procedure

Bump testing involves applying test gas to the detector and observing the readings from it. Readings should be obtained either from the detector's display or the controller display.

If it is required to monitor the current loop signal and there is no provision for accessing it within the installation wiring, the detector enclosure must be opened to gain access to the test terminals on the main circuit board.

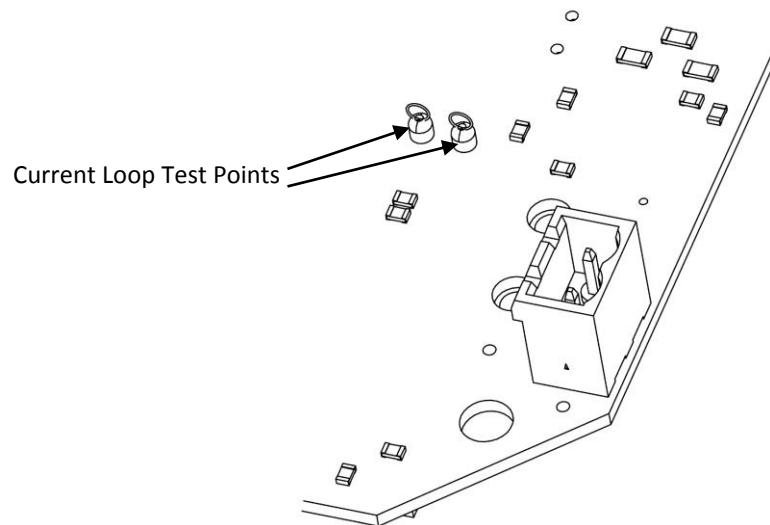

Do not short the test points to ground or connect to the shield or the signal return terminals. Doing so may cause damage to the detector electronics.

The bump test procedure should be carried out as follows (example assumes a 0 - 100ppm H₂S detector) :-

- Decide on the appropriate method for observing the readings (display / current loop).
- Remove the splash-guard from the detector gas entry port - the splash-guard is removed via two 4mm Allen key type screws. Attach the calibration adaptor (with attached 6mm hose) to the detectors gas inlet port by gently pushing it into place.
- Connect the hose to the purge gas cylinder regulator outlet.
- Turn on the nitrogen supply and allow to run for about 60 seconds.
- Observe the detector response (nitrogen still running).
- The display reading should be 0.0 ± 0.1 . The current loop output should be 4.00mA with a maximum variation from ideal of ± 0.016 mA.
- Switch off the purge gas

- Connect the hose to the target gas cylinder regulator outlet.
Observe all safety procedures surrounding the use of the gas.
- Turn on the gas and allow to run for about 60 seconds
- Observe the detector response (target gas still running).
- The display reading should be as per the gas concentration used for the test with a maximum deviation of ± 3.0 ppm. The current loop signal response will depend on the concentration of the target gas being used for the test.

The method for calculating the expected current loop reading is as follows:-

Read the gas concentration from the test gas cylinder (example 49.2 ppm)

Note the scale configuration of the detector under test (e.g. 0 - 100ppm. This is a 100ppm full scale detector).

Divide the test gas concentration by the detector full scale number (in this case $49.2 / 100$ giving 0.492)

Multiply this number by 16 (in this case 0.492×16 giving 7.872)

Add 4 to the above result (in this case $7.872 + 4$ giving 11.872)

The final result is the expected loop current in milliamps (11.872mA)

The observed reading on the test meter should be within $\pm 3.0\%$ of the instruments scale (approx. ± 0.32 mA)

If the readings from the detector are outside of the limits for either the purge gas or the target gas, a detector calibration will be necessary. Please refer to the sections in this manual covering the operating system for accessing the detector's calibration functions.

11. Detector Operating System

D-Guard² is shipped with the gas type and range configured per the end users requirements when purchased. In general, since many of the gas related functional settings are common to many applications, D-Guard² has been setup with the most commonly encountered configuration based on the selected gas type and range. For many end users and applications, no further setup is required.

For those applications that require alternative configurations, D-Guard² includes a comprehensive user interface system making modifications to system settings fast and efficient.

This same system gives access to commonly used calibration functions that will be required to be used on a regular basis to maintain detector performance. **A menu map for all of the available screens is given in appendix c.**

D-Guard² has a high resolution, high contrast LCD that provides clear and easy to read screens for all gas readings, status messages and menu items. The detector uses four magnetically sensitive switch devices that operate as user buttons (keys). The functionality of each button is context dependant, based on the menu screen in use. This system of 'soft-keys' is described in section 10.3.1.

11.1. Detector Power Up

For the first sixty seconds following power-up, D-Guard² displays the start-up screen. This is the detector 'warm-up' phase and holds the instrument in a default condition while the gas sensors stabilise. This reduces unpredictable system behaviour since the detector outputs a low fault current loop value during this phase. The connected system can identify that the detector is in a low signal state and act accordingly. This start-up action is desirable because during the warm-up period, the detector is essentially off-line and not reporting present gas values.

A numeric counter at the bottom of the display counts down from 60 to 0 as the warm-up time elapses.

After the 60 seconds time period expires, the detector moves to its main system read-out (Home) screen.



Initial Start-Up Screen.

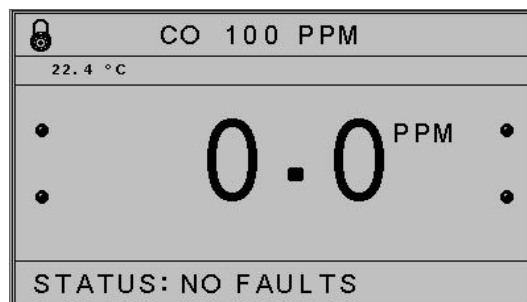

Detector 'Home' Screen.

11.2. Home Screen Features

The Home Screen is the main display that will be visible most of the time during normal detector operation. There are a number of functions indicated on the Home Screen in addition to the gas readout.

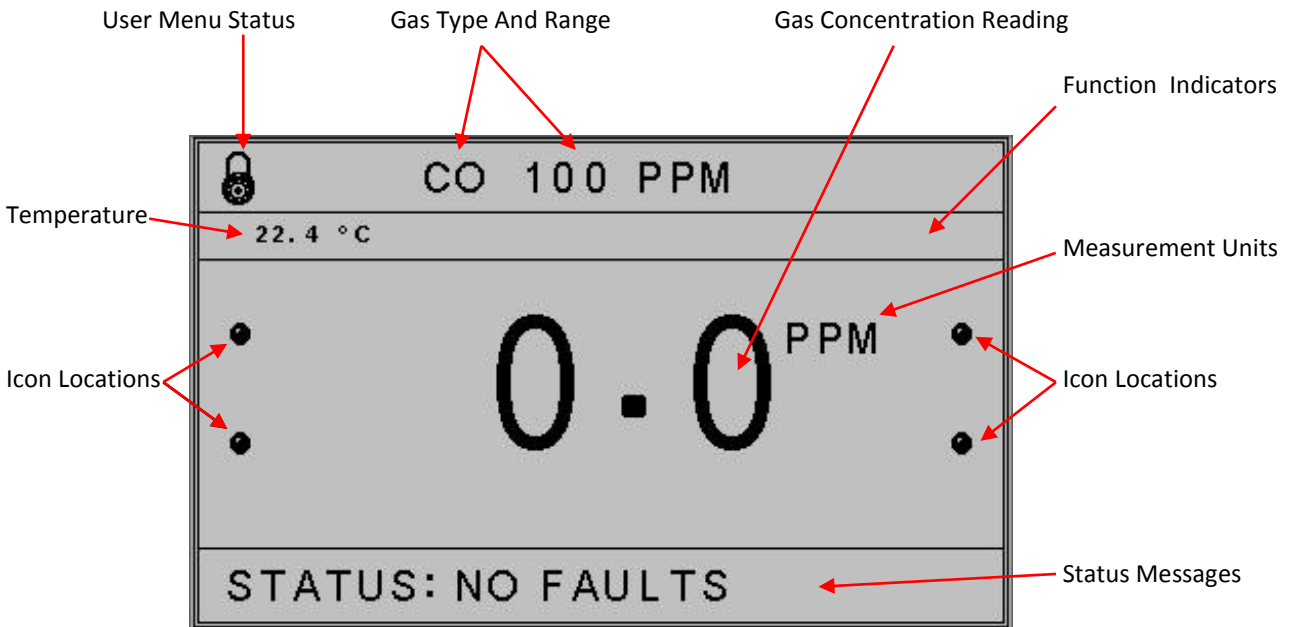

The main screen shows both permanent and dynamic areas to provide indication of detector status and gas readings.

11.2.1 User Menu status

Padlock Icon

The padlock icon is aligned with the top left user 'soft-key' and when present indicates that the menu system is locked. Access to the menu system requires a deliberate key action.

Gas Type And Range

This is a fixed indication of the detector's target gas and its full scale measuring range.

Temperature

This reading indicates the temperature within the detector body. The temperature value may differ from ambient temperature by a few degrees.

Icon Locations.

Depending on the status of the detector and/or specific menu pages, these locations on the display will be occupied by status icons. When an icon is not active, its place is marked by a small circle. Details of the icons are given in each section where it may be indicated.

Status Messages

This area of the display is dynamic and provides clear indication of specific conditions such as warn alarm, danger alarm, under/over range, sensor faults etc. The default indication for a detector operating normally is 'NO FAULTS'.

Measurement Units

This is a fixed display area showing the gas concentration units in use.

Function Indicators

Messages and icons in this area show when required to indicate that a system function is active or to guide the user.

11.3. Configuration and Calibration Menu Navigation System

D-Guard² uses a soft-key navigation system to allow fast access to various detector configuration and calibration functions. Depending on the context of the configuration or calibration screen being accessed, the four keys will have specific actions assigned to them.

Within each function screen, a guided help system provides information on present location within the menu system and guidance on performing the function relating to that menu location.

The four magnetic user keys are indicated by the four white circles on the front panel. Placing the magnetic stylus over these markers operates the key and performs the action that is assigned to it at the time.



Although the function of the keys change based on context, there are only a small number of basic key function icons to remember. There are also a number of 'fixed' key function locations to simplify navigation to common screens such as the home screen. If there is no icon next to a key marker, then that key has no effect.

11.3.1 Soft-Key Functions and Icons

Soft Key Icon	Function	Screen Location
	Return directly to the home screen	Always Top Left
	Go back one screen	Top Left or Top Right
	Next Screen	Always bottom Left
	Increment value or toggle selection	Always Top Right
	Decrement value / toggle selection / start action	Always Bottom Right
	Save changes	Always Top Left
	Enter setting page	Always bottom Right

11.3.2 Quick-Nav Function

To save the user from having to navigate past a large number of function screens to get to the desired page, a quick navigation system allow a direct jump to the general area of interest. *If no key is pressed, the home screen is automatically returned to after 20 seconds.*



11.3.3 Entering The Function Screens

To gain access to the function screens, the stylus must be held on the padlock icon continuously for a few seconds. Depending upon whether a pass-code has been set, the next screen will either be the menu choice bars (CAL / SET) or the screen for entering the pass-code.



Padlock Icon for 2 - 5 seconds

Menu is unlocked

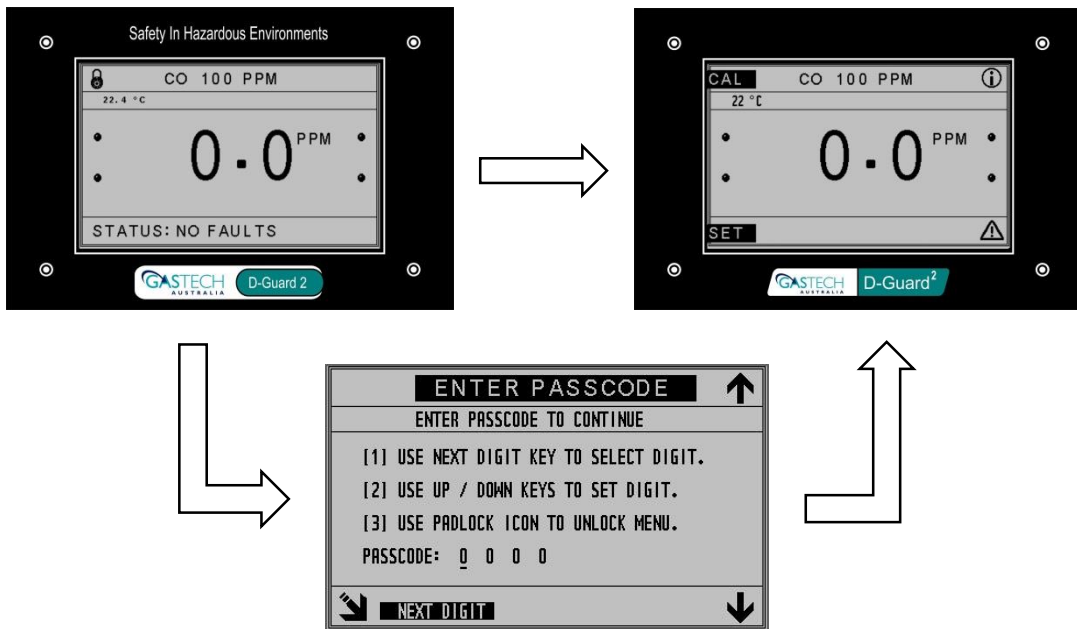

To enter the pass-code scroll each digit up or down. A padlock icon will show once a code is entered. Entering an incorrect code will move the menu back to the main home (measurement) screen. Once unlocked, if exited, the menu can be re-entered without the pass-code for 30 seconds, after which the menu is again locked and requires the pass-code to re-enter.

Once the menu is unlocked, two options are available, calibration '**CAL**' or setup '**SET**'. Operating the '**SET**' soft-key moves to the quick-nav screen described in section 10.3.2.

12. Calibration

12.1. Why Calibrate ?

All electro-chemical gas sensing cells have a finite service life. Through reactions with ambient atmosphere that may contain contaminants, and in some cases, to target gas, the internal electrodes slowly become less active and efficient. In operating conditions where the cell is not exposed to its target gas (other than for calibration purposes), and the surrounding environment does not contain volatile organic compounds (VOC), the cell should operate reliably for around 18 to 24 months.

Regular exposure to non-clean air, or VOC's will shorten the cells lifetime. The reduced lifetime will depend upon the frequency and nature of exposure to ideal 'clean-air' conditions. Once a cell has reached the limit of its lifetime, it must be replaced (see maintenance section).

For Infra-Red type sensors, the process of performance degradation is much slower and is generally related to changes in the characteristics of the optical components used to measure the gas concentration. Occasionally, detector operation in a harsh environment can cause stress to the optical components causing a shift in its performance.

For all sensor types, as a result of its aging mechanism, gas proportional electrical outputs will degrade from the levels they were when new. This signal degradation can be observed as a baseline measurement shift, either positive or negative. Similarly, the cell's sensitivity to gas will reduce with a corresponding reduction in output signal for a given gas concentration.

If left uncorrected, eventually the detector will no longer operate reliably in detecting its intended gas.

In order to maintain accurate and reliable operation, the detector must be calibrated at regular intervals. Calibration will return the detector to a correct zero gas baseline and re-adjust operation to compensate for the reduced cell sensitivity.

Some environmental standards mandate that detectors must be calibrated regularly if the monitoring system is to remain compliant with its rules. GasTech Australia recommends calibration at 3 monthly intervals for a detector operating under normal conditions.

12.2. Preparing for calibration

The method for calibrating the detector has similarities to bump testing. See sections 9.3 to 9.5.

To ready the detector for calibration, conduct the operations covered in sections 9.3 to 9.5.



Unlike bump testing however, a minimum target gas level of 25% of full scale must be used for calibration to ensure an accurate final calibration and for the detector to achieve its published performance specifications.

D-Guard² prevents zero calibrations from being performed if the apparent gas level is greater than 10% of full scale. Span calibrations are prevented if apparent gas concentration is less than 20% of full scale .

12.3. Zero Calibration

Zero calibration consists of applying a purge gas (i.e. a gas that does not contain any trace of the detector's intended target gas) and adjusting the detectors response accordingly. The output response of the detector is both the displayed value and the value of the current output on the current loop system. For detectors with HART communication enabled, measured values will be sent over the HART protocol also.

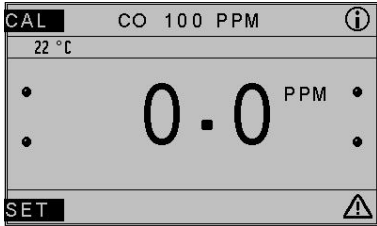
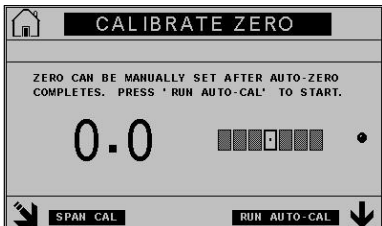
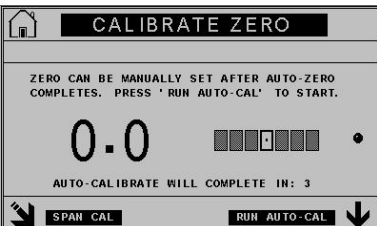
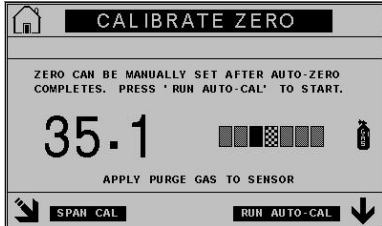
12.3.1 Auto-Zero Calibration

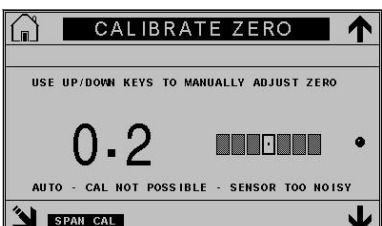
Unlocked Menu System Screen	The 'Calibrate Zero' page is now shown
	
<p>After unlocking the menu system, 'CAL' gives access to detector calibration, 'SET' gives access to the configuration functions. The ⓘ and ⚠ icons access detector information screens. Select 'CAL' to continue.</p>	<p>This page allows the detector's 'auto-zero' function to set the baseline value. Operate the 'Run Auto Cal; soft-key to continue. Purge gas should be applied to the detector at this time.</p>
Running The Auto Zero Process	Apply Purge Gas Warning
	
<p>Once the baseline gas is within the allowable range, the 'Run Auto Cal' soft-key can be used to start the process. A countdown timer indicates the time from pressing the key to the process beginning. During this time the trend bar may be observed for a stable reading as D-Guard² checks for a stable reading.</p>	<p>If the baseline gas concentration is greater than 10% of the detector's full scale, a warning to apply purge gas is displayed. A flashing gas cylinder icon is also displayed. The 'Run Auto Cal' soft-key will not operate at this stage. If not already connected, connect the purge gas supply to the detector to continue.</p>
Unstable Reading Warning	Auto Zero Fail Message
	
<p>If the sensor is old and has become electrically noisy, it is possible that the readings will not be stable. D-Guard² checks the noise level and flags a warning if it is too great to perform a reliable auto-zero calibration. The extent of the instability can be gauged by the distance the trend marker moves from the centre position. In some cases, if the sensor noise is variable, the detector may revert back to the auto-zero countdown. If instability returns, the stability warning screen will again be shown. D-Guard² re-tries the auto-zero process a number of times before stopping.</p>	<p>If D-Guard² has determined that an auto-zero is not possible, the up and down soft-keys will become enabled, allowing a manual zero adjustment to be made. It is important to note however that a zero set manually due to a noisy sensor will have to be based on best judgment of where the zero actually lies amongst noisy readings.</p>

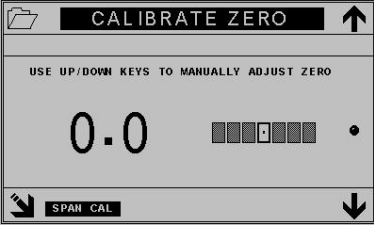
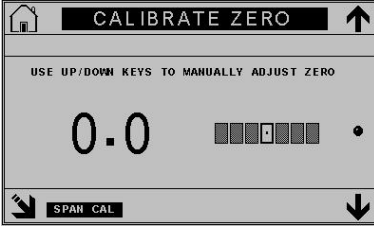
12.3.2 Saving the Zero Calibration Value	12.3.3 Manual Zero Calibration
	
<p>Once an auto-zero has successfully completed, the 'save' icon will show in the top right soft-key location. Operating the save key will store the zero calibration values and immediately start to use the new values as the baseline reading. Once saved, the save icon is replaced by the 'home' icon and the soft-key will return the detector back to the main screen if operated.</p>	<p>If a manual adjustment of the baseline is required after an auto-zero completes, the up and down soft-keys will increase or decrease the baseline reading. When a change in the reading has been made, the save icon will be indicated again. Saving the new manual set zero will store the reading and revert the soft-key icon back to the 'home' function.</p>

12.3.4 Notes On Zero Calibration

The purge gas source to the detector should be flowing at about 1 litre/min for the most reliable calibration. Flow rates of 0.5 litre/min are acceptable but may take longer to bring the sensor to a stable zero point. Flow rates lower than 0.5 litre/min are not generally recommended for calibration purposes.

the purge gas must be left flowing for as long as necessary to bring the readings to a stable baseline point. Generally this will be 60 - 120 seconds but could be as long as 5 minutes depending on the type of gas sensor and what was applied to it prior to the purge gas source.

The trend bar on the calibration screens is designed to allow more visibility regarding the signal trend. It is often difficult to gauge whether a reading is rising, falling or has stabilised by just looking at the displayed numbers.

The trend indicator will settle at the middle position once the raw sensor signal has stabilised and sat within a narrow band of values for around 5 seconds. Once the trend indication is in the centre position, the reading can be deemed stable enough to calibrate within the detectors specified accuracy limits.

It is important to note that over time, all gas sensors will show a small amount of cyclic readings. If the trend bar has been used to gauge a stable reading and a calibration is carried out based on it indicating the centre position, the numeric gas readings may still move from the point the calibration was set. This is normal and if observed long enough will show up as slowly increasing and decreasing readings that sit well within the detectors specified accuracy limits.

During all calibration functions, any zero-suppression settings are over-ridden and set to the 'off' state. Once calibration is completed and the main screen is returned to, zero-suppression will be set back to the state it was before entering calibration modes.

Following a zero calibration, the current loop signal should be checked for a correct reading of 4.00mA ± 0.03mA.

12.4. Span calibration

Span calibration consists of applying target gas of known concentration and adjusting the detectors response accordingly. The target gas is a mixture of gas that the detector is intended to detect and a balance gas such as nitrogen or instrument air). The output response of the detector is both the displayed value and the value of the current output on the current loop system. For detectors with HART communication enabled, measured values will be sent over the HART protocol also.

12.4.1 Auto Span Calibration

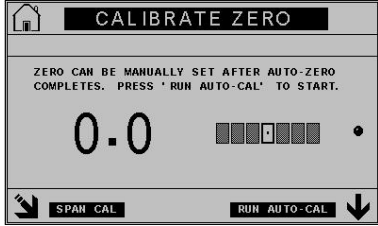
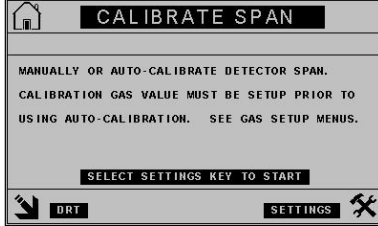
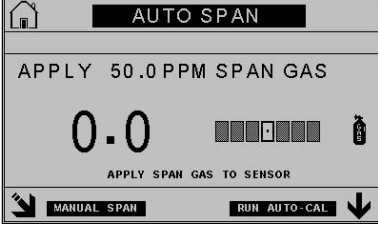
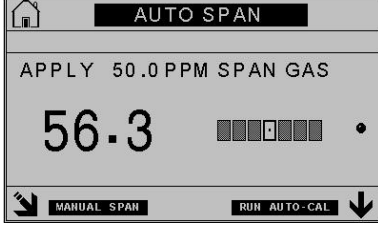
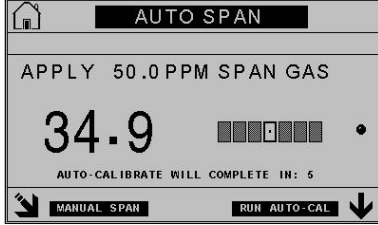
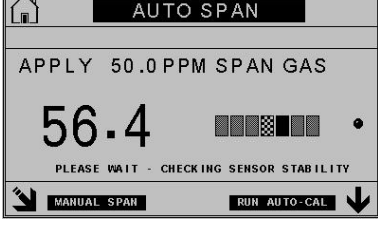
<p>After entering the calibration system</p>	<p>The 'Calibrate Span' information page is now shown</p>
	
<p>When entering the calibration functions, the zero calibration page is the first one seen. Operate the 'Span Cal' soft-key to move on to the span calibration pages.</p>	<p>This page provides information and guidance on using the span calibration functions available. Operate the 'Settings' soft-key to continue.</p>
<p>Auto Span Page - No Gas Applied</p>	<p>Auto Span Page - Target Gas Applied</p>
	
<p>The 'Settings' soft-key moves to the auto-span function. From here automatic span calibration can be started, or the manual span function accessed. A warning to apply the target gas is indicated. The expected span gas concentration is programmed into D-Guard² during manufacture. This can be user modified if required (see section 12.1.4 on how to do this). Until a valid target gas is applied, the warning message and gas cylinder icon will be displayed and the calibration process disabled. Target gas must be applied at this point to continue.</p>	<p>Once the target gas has been applied, the warnings will stop being indicated and the 'Run auto Cal' soft-key will become active. Observing the trend indicator will show when the gas reading has stabilised. If the marker is in the centre position, then the auto-span process can be started. If the marker is not in the centre position, the sensor has not stabilised and auto-span is not possible. To continue, operate the 'Run Auto Cal' soft-key.</p>
<p>Running the Auto Span Process</p>	<p>Unstable Reading Warning</p>
	
<p>After the 'Run Auto Cal' soft-key has been operated, a countdown period starts before the span calibration process begins. During this time D-Guard² checks the stability of the gas readings. The stability of the readings can be observed on the trend indicator. If the readings are stable and the trend marker is in the mid position, the auto-span process will start. If however, the readings are not stable a warning message will be shown.</p>	<p>If the sensor is old and has become electrically noisy, it is possible for the readings to be unstable. D-Guard² checks stability and shows a warning if instability is too great to perform an auto-span calibration. The extent of the instability can be gauged by the distance the trend marker moves from the centre. If the sensor stability is variable, the detector may revert back to the auto-span countdown. If instability returns, the stability warning screen will again be shown. D-Guard² re-tries the auto-zero process a number of times before stopping.</p>

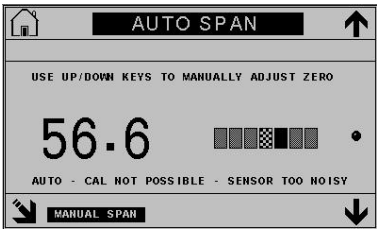
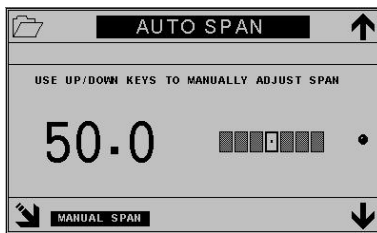
Auto Span Fail Message	12.4.2 Saving Auto-Span Calibration Values
	
<p>If D-Guard² has determined that an auto-span is not possible, the up and down soft-keys will become enabled, allowing a manual span adjustment to be made. It is important to note however that a span set manually due to a noisy sensor will have to be based on best judgment of where the reading actually lies amongst noisy readings. Once a change is made to the readings by the up and down soft-keys, the save settings icon will be shown (see next screen).</p>	<p>Once an auto-span has successfully completed (or a manual change is made due to a noisy sensor preventing auto-span from occurring), the 'save' icon will show in the top right soft-key location. Operating the save key will store the span calibration values and immediately start to use the new values as the baseline reading. Once saved, the save icon is replaced by the 'home' icon and the soft-key will return the detector back to the main screen if operated. Further manual changes will again cause the save icon to be displayed..</p>

12.4.3 Manual Span Calibration

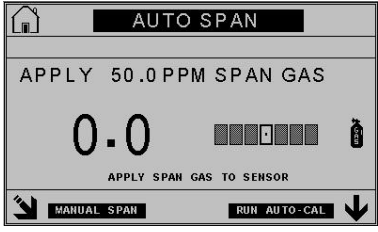
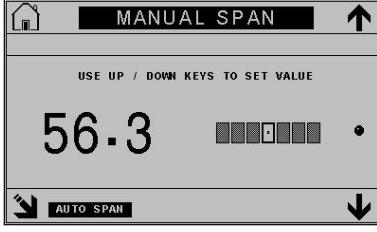
After entering the Span calibration screens	12.4.4 Performing a Manual Span Calibration
	
<p>When entering the span calibration functions, the auto-span page is the first one entered. Operate the 'Manual Span' soft-key to move on to the manual-span calibration pages.</p>	<p>Once in the manual span screen and span gas has been applied, the warning messages and icons will extinguish. The gas reading can now be adjusted by the use of the up and down soft-keys. Manual adjustment is best carried out when the trend indicator is sitting in the centre position indication a stable reading.</p>

12.4.5 Saving Manual Span Calibrations

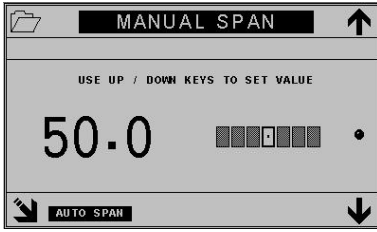
	
<p>Each time either the up or down soft-key is pressed, the 'home' icon will change to the 'save' icon. Once the save icon is visible, the current manually adjusted value can be saved by operating the 'save' soft-key. Once the value is saved, the soft-key reverts back to the 'home' icon. Any further changes to the reading using the up or down soft-keys will again show the 'save' icon.</p>	

12.4.6 Isolating the Detector During Span Calibration

If during calibration, it is required to prevent the current loop signal responding to the applied gas, set the detector into 'isolate mode'. Refer to section 12.4.2 for information on how to isolate the detector.

12.5. Current Loop Output Calibration

The current loop output signal is not expected to require re-adjustment under normal operating conditions.. If however setting is required, the following procedure describes the process.

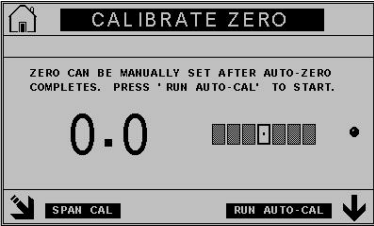
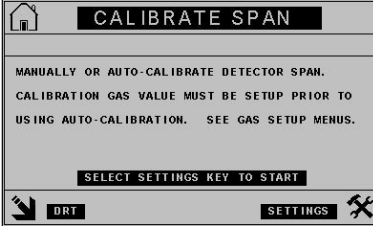
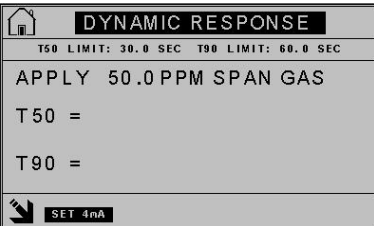
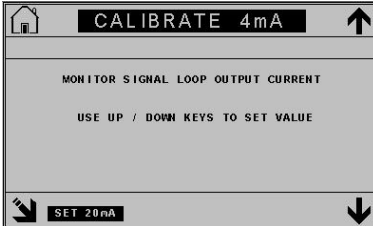
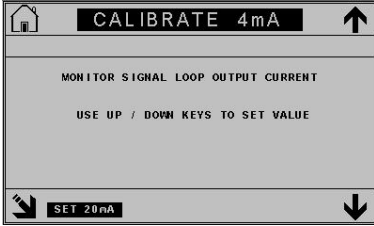
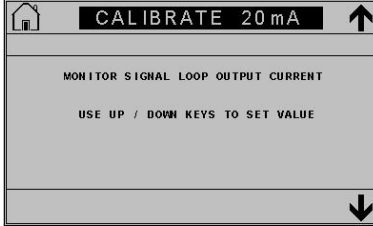
<p>After entering the calibration system</p>  <p>The screen shows 'CALIBRATE ZERO' at the top. Below it, text reads: 'ZERO CAN BE MANUALLY SET AFTER AUTO-ZERO COMPLETES. PRESS 'RUN AUTO-CAL' TO START.' A large digital display shows '0.0' followed by five small indicator bars and a dot. At the bottom, there are two soft-key options: 'SPAN CAL' on the left and 'RUN AUTO-CAL' on the right with a downward arrow.</p>	<p>Bottom left ('next') soft-key moves to the next screen</p>  <p>The screen shows 'CALIBRATE SPAN' at the top. Text reads: 'MANUALLY OR AUTO-CALIBRATE DETECTOR SPAN. CALIBRATION GAS VALUE MUST BE SETUP PRIOR TO USING AUTO-CALIBRATION. SEE GAS SETUP MENUS.' Below this is a button 'SELECT SETTINGS KEY TO START'. At the bottom, there are two soft-key options: 'DRT' on the left and 'SETTINGS' on the right with a wrench icon.</p>
<p>From the zero calibration page, operate the 'Span Cal' soft-key to move on to the next screen (span calibration page).</p>	<p>The second screen is span calibration . Operate the 'DRT' soft-key to move to the next screen (DRT).</p>
<p>Bottom left ('next') soft-key moves to the next screen</p>  <p>The screen shows 'DYNAMIC RESPONSE' at the top. Text reads: 'T50 LIMIT: 30.0 SEC T90 LIMIT: 60.0 SEC' and 'APPLY 50.0 PPM SPAN GAS'. Below this are two input fields: 'T50 =' and 'T90 ='. At the bottom, there is a soft-key option 'SET 4mA'.</p>	<p>12.5.1 Setting the 4mA Output Current</p>  <p>The screen shows 'CALIBRATE 4mA' at the top with an upward arrow. Text reads: 'MONITOR SIGNAL LOOP OUTPUT CURRENT' and 'USE UP / DOWN KEYS TO SET VALUE'. At the bottom, there is a soft-key option 'SET 20mA' with a downward arrow.</p>
<p>The third screen is the DRT function screen. Operate the 'SET 4mA' soft-key to move to the 4mA calibration screen.</p>	<p>To adjust the 4mA output signal, place a digital multi-meter on the 'Loop' test point pins on the main system board. Operate the up or down soft-keys to adjust the current loop output value. The setting will be fairly sensitive if the current loop value is close the ideal value. Short 'dabs' of the up and down keys should be sufficient to bring the value back into the correct range. Each time a change is made, the 'home' icon' will change to the 'save' icon. One a value is saved, the icon will revert to the 'home' icon. Further changes will again show the 'save' icon. The final value must be 4.00mA ± 0.01mA</p>
<p>From the 4mA calibration screen</p>  <p>The screen shows 'CALIBRATE 4mA' at the top with an upward arrow. Text reads: 'MONITOR SIGNAL LOOP OUTPUT CURRENT' and 'USE UP / DOWN KEYS TO SET VALUE'. At the bottom, there is a soft-key option 'SET 20mA' with a downward arrow.</p>	<p>12.5.2 Setting the 20mA output Current</p>  <p>The screen shows 'CALIBRATE 20mA' at the top with an upward arrow. Text reads: 'MONITOR SIGNAL LOOP OUTPUT CURRENT' and 'USE UP / DOWN KEYS TO SET VALUE'. At the bottom, there is a soft-key option with a downward arrow.</p>
<p>From the 4mA calibration screen, operate the 'SET 20mA' soft-key to move to the 20mA calibration screen.</p>	<p>To adjust the 20mA output signal, place a digital multi-meter on the 'Loop' test point pins on the main system board. Operate the up or down soft-keys to adjust the current loop output value. The setting will be fairly sensitive if the current loop value is close the ideal value. Short 'dabs' of the up and down keys should be sufficient to bring the value back into the correct range. Each time a change is made, the 'home' icon' will change to the 'save' icon. One a value is saved, the icon will revert to the 'home' icon. Further changes will again show the 'save' icon. The final value must be 20.00mA ± 0.01mA</p>

12.6. Dynamic Response Time Test Function

The Dynamic Response Time (DRT) test function allow the operator to perform a check on the actual gas measurement response time for the detector. Unlike a 'static' calibration where the adjustments are made to bring the readings to an expected steady state calibrated value, DRT dynamically checks the time taken for the gas reading to reach both 50% and 90% of the applied gas value. This check is carried out when the detector is new and the timing values stored as a reference. User DRT checks use these stored values to compare against. Reading response time can slow down if waterproof membranes become clogged or sensors become old and unresponsive.

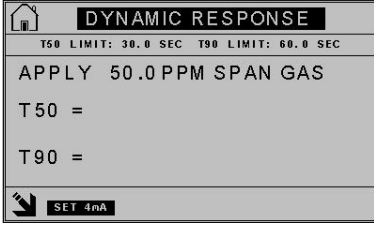
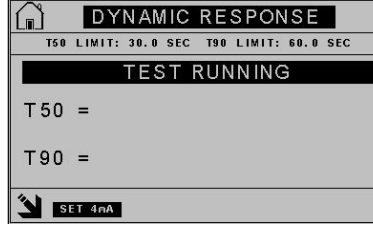
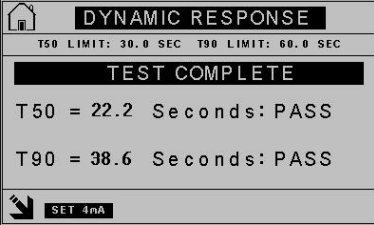
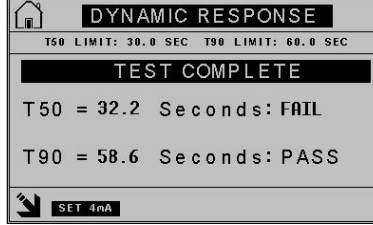
Dynamic Response Time Test Screen	12.6.1 Running the DRT Checks
	
<p>The DRT main screen displays entries for T50 and T90 response times. Until gas is applied, these values are blanks and the detector waits for gas to be applied to trigger the start of the checks.</p> <p>The target timing values are shown in the upper status banner.</p>	<p>Once test gas is applied, the test begins automatically. A message indicating the test is running is displayed. Note: it is absolutely essential to use the same span gas concentration each time this test is carried out. This gas concentration must be set in the user calibration gas setup menu (see section 12.1.4). If the same gas concentration is not used for each test, the results will not reflect a proper comparison against the stored reference timings.</p>
Test Completed - All Passed	Test Completed - Failures
	
<p>Once the measured gas concentration reaches 90% of the applied gas, the test will complete and the results displayed. If both timings for T50 and T90 were within the reference values, then the test is passed. Results are stored in the detectors eeprom.</p>	<p>It is possible for one of the tests to fail if the sensors response is no longer close to the typical exponential type curve that gas sensors exhibit. Old sensors can be very slow to respond making it possible for the T50 to fail but the T90 to pass. Of course a very slow, old sensor or badly blocked waterproof membrane could cause both tests to fail.</p>

13. Detector Configuration

As supplied to the end user, D-Guard² is configured based on the selected gas type and range. For the majority of applications most of these 'default' settings should not require adjustment.

The system of configuration menu screens works essentially the same way as those used for the calibration functions. Navigation uses the same general soft-key layout and the format of the screens is the same as for calibration functions.



The 'Quick-Nav' system screen allows a direct jump to the area of interest to save scrolling through numerous pages see section 10.3.2 for use of the Quick-Nav function.

The following configuration sections are provided along with the specific parameters that can be adjusted.

13.1. Sensor Configurations

Sensor Setup Main Screen	
<p>When 'SET' is selected from the Quick-Nav screen, the main Sensor setup screen is shown. Select the 'SETTINGS' soft-key to start sensor configuration.</p>	

13.1.1 Set Guard Band

This setting allows the user to enable or disable the measurement guard band (or zero-suppression) that assists in keeping the detector's baseline readings stable. This suppression band is hard coded into D-Guard² and holds the readings at zero only whilst they are close to a real zero point. This function is most often used to prevent negative readings. The user can set the Guard band on or off.

Guard Band OFF	Guard Band ON
<p>From the Guard Band OFF position, use the up and down soft-keys to toggle between ON and OFF. Once a change is made, the 'home' icon changes to the 'save' icon.</p>	<p>Once the change is made and the 'save' icon is showing, the selection can be committed and saved to eeprom. Once saved, the 'save' icon reverts to the 'back' icon. To move to the Set Auto-Zero screen, operate the 'NEXT PARAMETER' soft-key. To return home, keep pressing the back soft-key until the main sensor setup screen is displayed with the home icon showing.</p>

13.1.2 Set Measurement Full-Scale

This setting allows the user to adjust the full scale measurement range of the instrument, up or down from that set by default. The end user may change the full scale range in increments of 5ppm for all sensor types except Infra-Red. Infra-Red sensors types will indicate a 'Change not allowed' message.



Care must be exercised when setting higher than default full scale values since at some point, for any given detector gain setting, the accuracy of the current loop output signal will degrade.

Full scale range should be set only after proper consideration to what minimum resolution is acceptable. Additionally there is an upper limit to the sensor signal level that can be handled by the system electronics before 'saturation' occurs.

Once the sensor signal level has reached this saturation level, no further increase in reading is possible, irrespective of the value set as a full scale range.

Set Measurement Full Scale	Detector Type Setup Screen
<p>For all sensor types except Infra-Red, the full scale range of the instrument may be set to a different value than the default. Increments are in units of 5ppm. Note that if the full scale range is set too high, for the current detector gain setting readings may become unstable.</p>	<p>Gas type is selected by the use of the up and down soft-keys. When a change is made, the 'home' icon changes to the 'save' icon. When the changes are saved, the detector reboots to make the changes effective.</p>

13.1.3 Detector Type

This setting allows the detector to be configured for a specific target gas and full scale measurements range.



This setting is intended to be used by end users ONLY if they are competent to do so. Changing this setting must only be carried out on advice from GasTech service engineers or authorised representatives. Changing the detector to a different gas type without changing the sensor type to match will result in incorrect detector operation or malfunction. GasTech Australia will not accept responsibility for events that may occur following changes made by non-competent personnel.*

**Competence within this context implies training having been given by GasTech Australia.*



Once a change to gas type and range is made and saved, the detector reboots to effect the changes. The calibration and configuration state are returned to default, requiring the instrument to be re-calibrated and any user configurations reinstated.

13.1.4 Setting Span Gas Concentration

This setting allows the user to enter the gas concentration value being used to calibrate the D-Guard². D-Guard² is shipped with a default value that relates to the gas range selected. This value may be set to match the most commonly used concentration value that the user will present to the detector during span calibrations and DRT tests. **Note, if a calibration gas is used that does not match the value set into this function, auto-span and DRT checks will not be accurate.**



Note: For most measurement types, concentration adjustment is settable to one decimal place. For measurement types with full scale ranges of 1ppm / 2ppm / 5ppm and for Infra-Red sensor types, 2 decimal places of calibration gas setting value is provided.

Default Span Gas Value	Modified Span Gas Value
<p>From the default calibration gas value, use the up and down soft-keys to increase or decrease the value. The up and down soft-keys are accelerated so continuing to hold the key changes the value more quickly. Once a change is made the 'home' icon changes to the 'save' icon.</p>	<p>Once the change is made and the 'save' icon is showing, the selection can be committed and saved to eeprom. Once saved, the 'save' icon reverts to the 'back' icon allowing the previous setup function to be accessed if required. To move to the Set Auto-Zero screen, operate the 'NEXT PARAMETER' soft-key. To return home, keep pressing the back soft-key until the main sensor setup screen is displayed with the home icon showing.</p>

13.2. Alarm Configuration



D-Guard² contains 2 gas concentration based alarms that provide indication that the measured gas has reached or exceeded a certain threshold. This threshold is the alarm set-point value stored within the D-Guard² configuration settings.



When an alarm set-point is reached, a number of actions are taken depending on the variant of D-Guard² being used. For detector versions with optional relays fitted, the appropriate relay (warn or danger) will change state. For detectors without relays but with HART communications, the alarm state is transmitted over the digital communication link. For Detectors without relays or HART communications, alarm conditions are signalled on the display as messages and icons.

As with the sensor configuration, most, if not all of the settings are pre-set during the detectors manufacture with the most commonly encountered configuration. However, the end user may wish to modify these defaults to match a particular application.

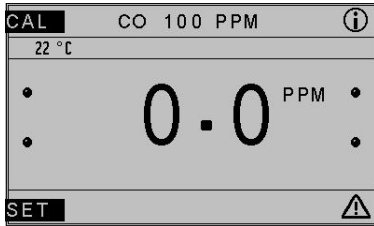
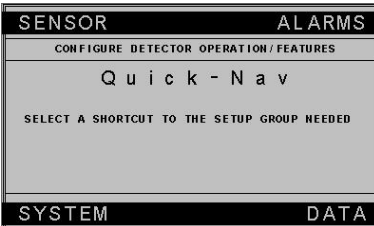
The descriptions relating to alarm configurations given in the next sections relate to 'Alarm 1', however, the process is identical for making changes to 'Alarm 2'

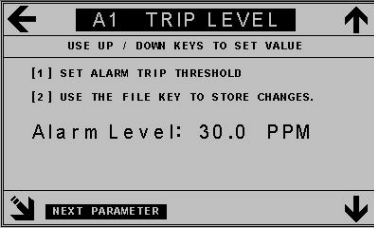
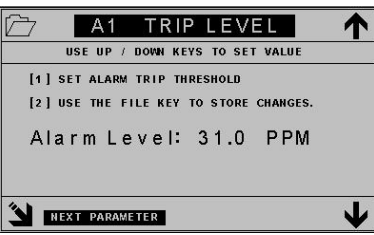
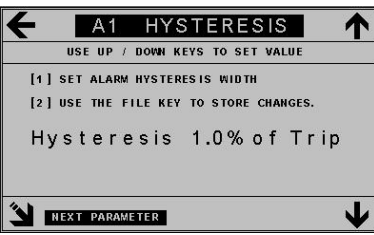
13.2.1 Making Alarm Configuration Changes (Alarm 1 shown)

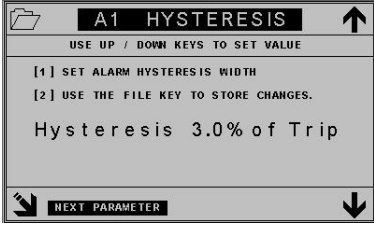
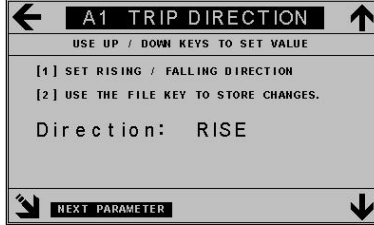
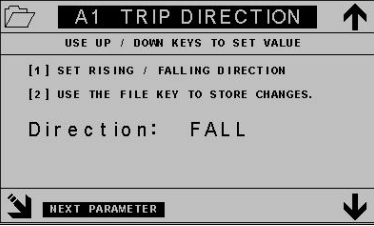
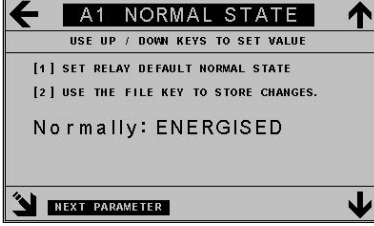
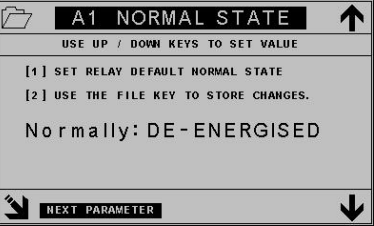
Unlocked Menu System Screen	Quick-Nav Screen
	
<p>To Enter the relay setup screens, start by unlocking the menu system. Hold the magnetic stylus over padlock icon for 5 seconds. After 5 seconds has expired (or correct passcode entered), the calibration and setup option soft-keys are activated. Select 'SET' to move to the 'Quick-Nav' screen.</p>	<p>Once in the 'Quick-Nav' screen, operate the 'ALARMS' soft-key to move to Alarm 1 Setup start page.</p>
Alarm 1 Current Settings Screen	13.2.2 Alarm 1 Trip Level
	
<p>The Alarm 1 setup start page displays the current settings for this alarm. Operating the 'BACK' soft-key will move to the previous part of the menu system (Sensor Setup - refer to appendix a menu map). To move to make settings to Alarm 2 instead of Alarm 1, operate the 'ALARM 2' soft-key. To start making changes to Alarm 1, operate the 'SETTINGS' soft-key.</p>	<p>To adjust the trip threshold for Alarm 1, use the up and down soft-keys to increase or decrease the value. The keys are accelerated to make the increments/decrements move more quickly as the key is held. To move back to the previous screen, operate the 'BACK' arrow soft-key. To move to the next parameter to change, use the 'NEXT PARAMETER' soft-key. Note: if these keys are operated before the save icon is visible, any changes made will not be saved.</p>
Alarm 1 Trip Level Adjusted	13.2.3 Alarm 1 Hysteresis
	
<p>Once a change has been made, the 'BACK' arrow icon will be replaced by the 'save' icon. Operating the save soft-key will commit the changes to the detector's configuration memory. Once saved, the back arrow icon will once again show. Making further changes will return the back arrow icon to the save icon. Use the 'NEXT PARAMETER' soft-key to move to the next parameter to change (hysteresis).</p>	<p>Hysteresis may be set from 0% to 10% of the currently set alarm set-point and operates on the alarm deactivation point. For example if the set-point is 10ppm and the hysteresis is set to 10%, the alarm will activate at 10ppm and deactivate at 9ppm. Use the up and down soft-keys to increment or decrement the value. The keys are accelerated to make the changes more quickly for keys held down.</p>

Alarm 1 Hysteresis Adjusted	13.2.4 Alarm 1 Trip Direction
	
<p>Once a change has been made, the 'BACK' arrow icon will be replaced by the 'save' icon. Operating the save soft-key will commit the changes to the detector's configuration memory. Once saved, the back arrow icon will once again show. Making further changes will return the back arrow icon to the save icon.</p> <p>Use the "NEXT PARAMETER" soft-key to move to the next parameter to change (Alarm Trip Direction).</p>	<p>Alarm trip direction may be set either Rising (RISE) or falling (FALL) and sets when the alarm should become active in relation to an increasing or decreasing measured gas concentration. The default settings are based on the gas type currently selected and configured.</p> <p>A warning will be indicated if a direction is set that may be inappropriate to the selected gas type is made.</p> <p>Use the up or down soft-keys to toggle the setting between rise and fall.</p>
Alarm 1 Trip Direction Changed	13.2.5 Alarm 1 Normal State
	
<p>Once a change has been made, the 'BACK' arrow icon will be replaced by the 'save' icon. Operating the save soft-key will commit the changes to the detector's configuration memory. Once saved, the back arrow icon will once again show. Making further changes will return the back arrow icon to the save icon.</p> <p>Use the "NEXT PARAMETER" soft-key to move to the next parameter to change (Alarm Normal State).</p>	<p>Alarm Normal State sets whether a relay (when fitted) is in an energised or de-energised condition under normal (non-alarm) operating conditions. The default is always 'normally energised' since this provides failsafe indication of power failure to the detector.</p> <p>Use the up or down soft-keys to toggle the setting between 'ENERGISED' and DE-ENERGISED'.</p>
Alarm 1 Normal State Changed	13.2.6 Alarm 1 Latching
	
<p>Once a change has been made, the 'BACK' arrow icon will be replaced by the 'save' icon. Operating the save soft-key will commit the changes to the detector's configuration memory. Once saved, the back arrow icon will once again show. Making further changes will return the back arrow icon to the save icon.</p> <p>Use the "NEXT PARAMETER" soft-key to move to the next parameter to change (Alarm Latching).</p>	<p>Alarm Latching sets whether a relay (when fitted) will remain in its alarm state after the condition that caused it to trip has subsided. An unlatched relay will immediately return to its default state once the gas event causing the trip to occur has dropped below the trip-point. A latched relay will remain in the alarm state until a manual reset action is carried out. The default state is Non-Latched.</p> <p>Use the up or down soft-keys to toggle the setting between 'NON-LATCHED' and 'LATCHED'.</p>

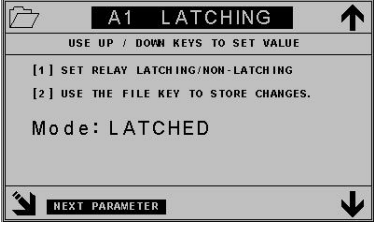
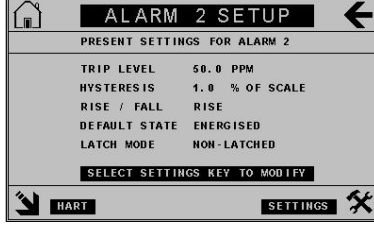
Alarm 1 Latching Changed	13.2.7 Alarm 2 Current Settings Screen
	
<p>Once a change has been made, the 'BACK' arrow icon will be replaced by the 'save' icon. Operating the save soft-key will commit the changes to the detector's configuration memory. Once saved, the back arrow icon will once again show. Making further changes will return the back arrow icon to the save icon.</p> <p>Use the "NEXT PARAMETER" soft-key to move back to the first Alarm setting (Alarm Trip Level).</p>	<p>All settings for Alarm 1 also relate to Alarm 2 and are adjusted in the same way as described for Alarm 1. Alarm 2 settings can be accessed from the Alarm 1 current settings screen or by operating the 'NEXT' arrow soft-key from the 'Sensor Setup' then selecting Alarm 2</p>

13.3. Digital Data Configuration

D-Guard² data communication uses a 'Bell 202' FSK type system that is compliant with the HART Communication Foundation protocol. Data is transmitted and received over the detectors 2-wire connections. The protocol used is compatible with version 7.0 of the protocol.

Full details of the configuration and use of the HART communications is covered in the HART implementation manual. Within the detector there are numerous registers that must be populated with detector identification data and others that can optionally be used to convey useful information to the connected system. These registers are accessed via the HART communications link using a HART Field Communicator / Configurator. D-Guard² allows the HART functionality to be turned on or off from the user menu and to read the HART register data (product ID etc.).

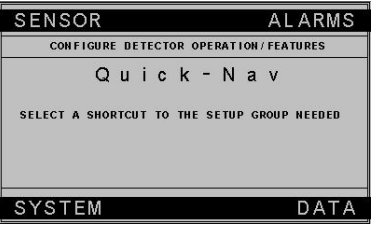
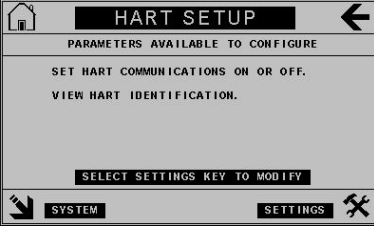
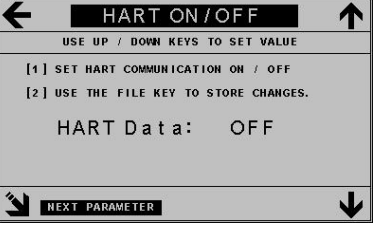
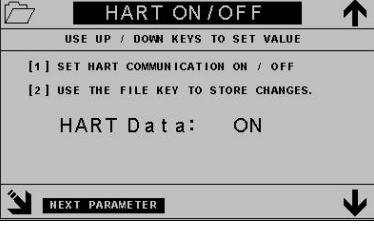
Data Setup is accessed from the Quick-Nav Screen	13.3.1 HART Setup Main Screen
	
<p>To access the HART data setup, unlock the menu and operate the 'DATA' soft-key</p>	<p>The main HART setup page displays the features that may be configured by the user.</p> <p>Operate the 'SETTINGS' soft-key to start configuration.</p>
13.3.2 Turning HART Communications On or OFF	
	
<p>The default state for HART communications is OFF.</p> <p>Use the up or down soft-keys to toggle the setting between 'ON and 'OFF'.</p>	<p>Once a change is made the save icon will show. Operate the 'save' soft-key to commit the changes to configuration memory. Following the save, the detector will reboot.</p>

13.3.3 HART Tag data	13.3.4 HART Tag data – fixed loop mode
<p>Navigating to the 'VIEW HART TAGS' screen allows the detector ID strings to be viewed (read only), along with other relevant HART related parameters. For full details, refer to the D-Guard² HART implementation manual.</p>	<p>The present communication operating mode of the detector's is reflected in the screen top banner. 'Variable' indicates that the detector is set for 'point to point' operation. If the detector is operating in 'multi-drop mode', the fixed current loop value is indicated.</p>

13.4. System Configuration

The system configuration screen allows configuration of the detector in a general sense, such as detector isolation.

System Setup is accessed from the Quick-Nav Screen	13.4.1 SYSTEM Setup Main Screen
<p>To access the SYSTEM data setup, unlock the menu and operate the 'SYSTEM' soft-key.</p>	<p>The main SYSTEM setup page displays the features that may be configured by the user. Operate the 'SETTINGS' soft-key to start configuration.</p>
13.4.2 Turning Detector Isolation On or OFF	
<p>The default state for isolation is OFF. Use the up or down soft-keys to toggle the setting between 'NOT ISOLATED' and 'ISOLATED'.</p>	<p>Once a change is made the save icon will show. Operate the 'save' soft-key to commit the changes to configuration memory. When isolated, the output current is fixed at 3.3mA. The main measurement screen indicates a clear message that the detector is in isolate mode.</p>

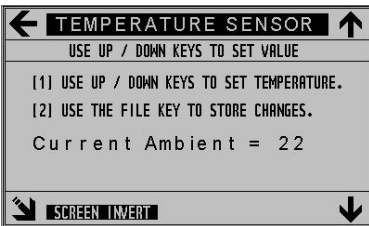
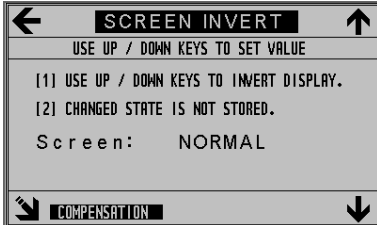
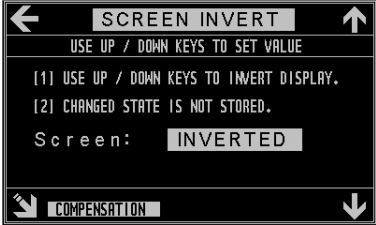
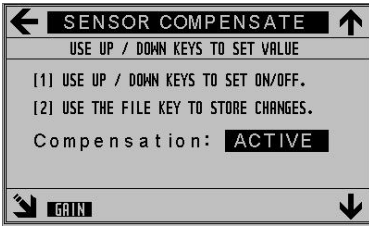
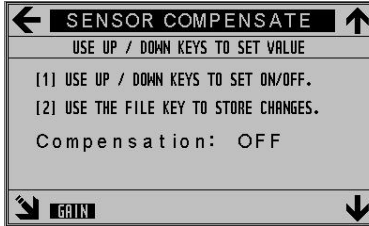
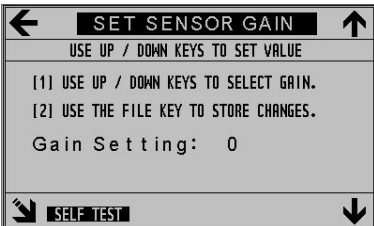
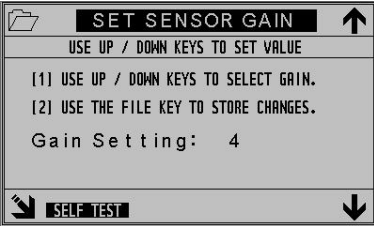
13.4.3 Internal Temperature Sensor	
	
<p>The temperature sensor monitors the detector's internal and sensor operating temperatures. Its purpose is to provide information as to the detector's operating conditions (as part of the built-in self test system) and for use in the sensor temperature compensation system. This setting is a calibration point for the temperature sensor. It is factory set and stored, but the user can make non-saved changes to this value. The value should be set to the current operating temperature of the detector. The user set value will persist as long as power is applied to the detector.</p>	
13.4.4 Display Colour Invert	
	
<p>The detector display can be set to appear as normal black on white images, or as an 'inverted' white on black image.</p>	<p>Changes are automatically saved.</p>
13.4.5 Sensor Temperature Compensation	
	
<p>Sensor temperature compensation may be turned on or off as required. Compensation against temperature changes is optimised for the sensors supplied with the detector and those supplied by GasTech Australia.</p>	<p>Changing to sensor types other than those supplied by GasTech Australia may require that compensation be turned off to achieve optimal performance.</p>
13.4.6 Set Sensor Gain	
	
<p>The 'gain' of the sensor processing electronics may be adjusted to 7 different values. As supplied, the gain is optimal for the sensor fitted and the gas range selected.</p>	<p>Changing this setting requires an understanding of sensor signal levels. Please consult GasTech Australia for advice on when and how to set this parameter.</p>

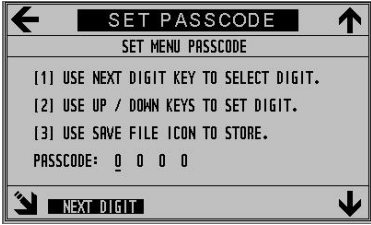
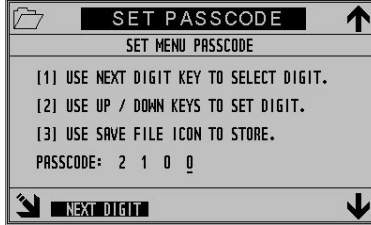
13.4.7 Set Menu Passcode	
	
<p>Access to the detector's menu system can be protected via the use of a 4-digit passcode. The default passcode is 0000 which disables the protection. Setting any other number than 0000 will enable the protection system. Changes made here are automatically saved. Use the 'up' and 'down' keys to increment or decrement the numeric digit. Use the 'next' key to select the next digit to change.</p>	<p>Once a digit is changed, the save icon will show to allow the change to be recorded. Selecting another digit or changing the value of the current digit will change the save icon to the 'back' icon.</p> <p>The saved passcode should be noted down for safe keeping since access to the user menu is not possible if the security system is active and an incorrect passcode is entered.</p>

14. Detector Messages and Warning States

During normal detector operation, the display indicates gas concentration values, and additionally, other operational information such as sensor temperature, gas measurement units and communication status.

Under conditions where a detector fault or a measurement error has occurred, the display will indicate the condition with a status message and icons.

14.1. Running Information and Fault Messages.

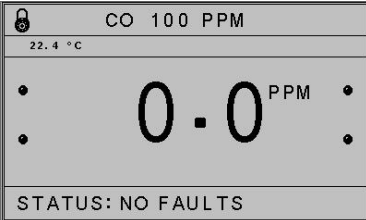
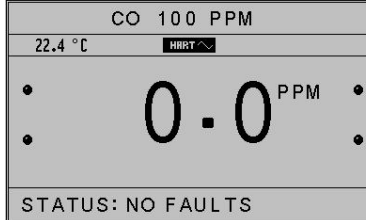
14.1.1 HART Communications Active	
	
<p>The digital communications Icon alternates between off and on whilst data packets are being received AND transmitted successfully. If received or transmitted data packets fail, or if communication is not active, the icon will turn off.</p>	

During the detectors routine operation, internal checks are made to determine if the system is functioning within normal limits. If a condition exists within the detector that could create unreliable measurements, the system fault icon is displayed. The lower status bar indicates a message associated with the fault condition.

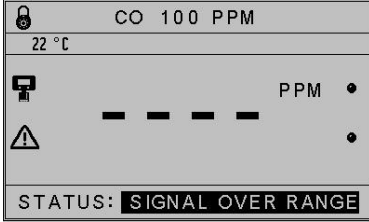
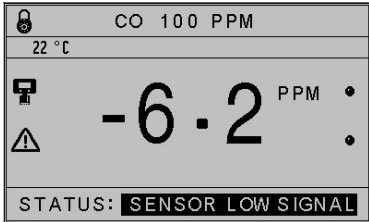
14.1.2 Detector Fault - Detector Over-Range	14.1.3 Detector Fault - Detector Under-Range
	
<p>If the detector reading exceeds the full scale measurement range by 10% the over-range is displayed by four dashed markers in place of the readout. Additionally, the warning triangle and sensor fault icons are displayed since an over-range condition can also be the result of a sensor failure. Whilst the fault condition is occurring both icons will be displayed. If the fault clears, the warning icon remains in place to indicate that a fault log is active.</p>	<p>If the gas sensing element is producing a signal that forces the reading into a negative state (possibly due to poor calibration or damage), the display will indicate 'SENSOR LOW SIGNAL' in the lower status bar and display both the warning triangle icon and the sensor fault icon.</p>

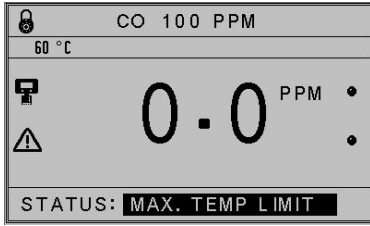
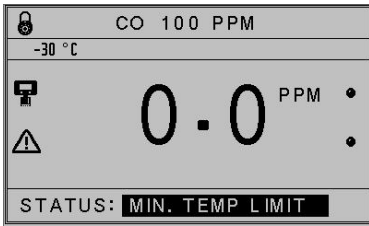
14.1.4 Detector Fault – Upper Operating Temperature	14.1.5 Detector Fault – Lower Operating Temperature
	
<p>During normal operation and during calibrations, the detector temperature is compared against an upper limit. If this limit is exceeded, then a fault message is displayed and the fault icons displayed. The fault is also logged in the fault list.</p>	<p>A similar check is made against a lower temperature limit. A fault message and icons are displayed if the detector is operated or calibrated beyond this limit.</p>

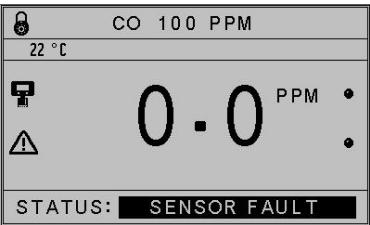
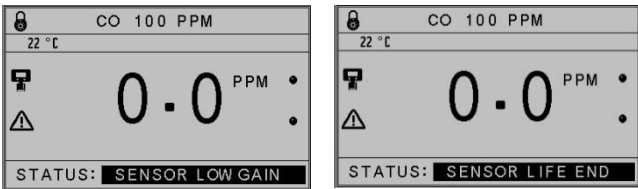
14.1.6 Detector Fault – Sensor Presence Failure	14.1.7 Detector Fault – Low Sensor Sensitivity
	
<p>The detector performs a periodic check on the gas sensor to ensure that it is both present and operating within a healthy state. If the check reveals that the sensor is not present (or behaving as if it were not present), a fault message and icons will be displayed. The fault is also logged in the fault list. This fault is cleared by checking the condition of the sensor and replacing if required.</p>	<p>Each time the detector is span calibrated, a check of the sensors gain performance is made. If the sensor has reached a point where unstable readings are possible, a fault message and icons will be displayed. The fault is also logged in the fault list. The actual sensor life remaining can be viewed on the detector information screen. This fault is cleared by changing the sensor, re-calibrating the detector and resetting the sensor life counter.</p>

14.2. Fault Log And Information Screens

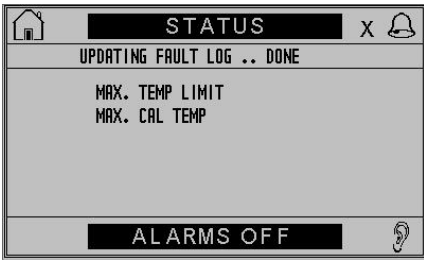
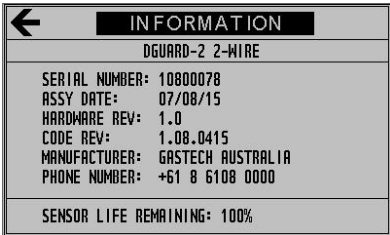
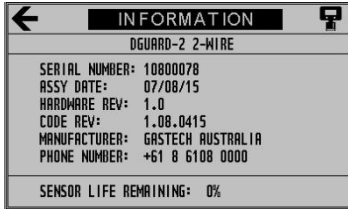
14.2.1 Detector Fault Log	14.2.2 Detector Information Screen
	 <p>The detector information screen contains the units serial number, the date of manufacture, hardware and firmware revisions and GasTech Australia company information.</p>
<p>Every fault event that occurs within the detector is added to the fault list. If a fault is still present, both the gas detector icon and warning icon will be present on the main measurement screen. If a fault has occurred and has cleared, then the gas detector icon will be cleared with just the warning triangle icon visible. The warning icon flags the user to enter the detector status screen to check for events that occurred. The list updates once the status screen is entered. Any faults present or past are contained in the list. Only one entry for each fault type is included. The list may be cleared by operating the 'cross' icon at the top right of the screen. This will also clear any current alarm states. If the fault condition still persists, the fault will reappear in the list after being cleared.</p>	<p>14.2.3 Resetting the Detector Life Counter</p>  <p>This screen also indicates the sensor life remaining. Once a sensor has expired and been replaced, the life counter can be reset by using the detector icon at the top right of the screen.</p>

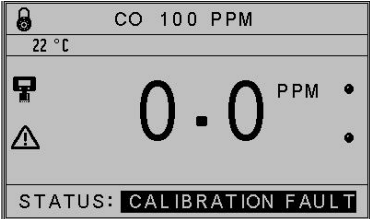
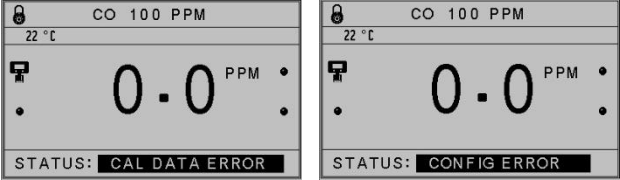
14.2.4 Calibration Fault	14.2.5 Internal Parameter Storage Fault
	
<p>If the detector has been re-configured to a different type via the system menu, the calibration state of the instrument is returned to the default condition as new – i.e. not calibrated. The instrument requires a zero and full scale calibration following a sensor type change. To indicate that a calibration is required, the display indicates the warning message 'CALIBRATION FAULT'. This message automatically clears once the calibrations are completed.</p>	<p>During the detector's start up sequence, critical calibration and configuration data that is stored in the instruments non-volatile memory is checked for consistency. The same checks are made when any calibration of configuration parameters are changed by the user. If the stored data has become corrupted the display will indicate a warning message to show that either the calibration or configuration system data is not healthy. To clear this warning, try recalibrating or reconfiguring the detector. If these steps do not clear the fault, please call GasTech Australia for advice.</p>

15. Alarm Indication

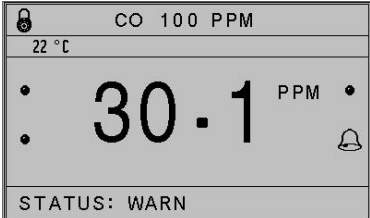
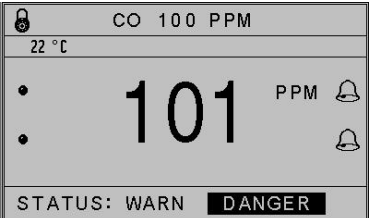
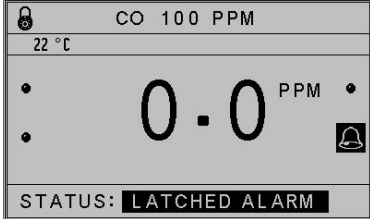
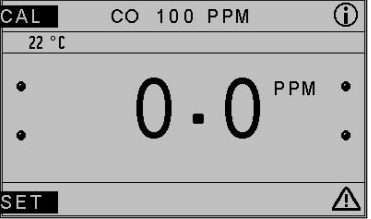
15.1.1 Warn Alarm Indication	15.1.2 Danger Alarm Indication
	
<p>If the measured gas concentration reaches the set-point programmed into the detector for a warn condition, the detector will signal this via a message in the lower status bar. Additionally a static alarm bell icon will be displayed. If the detector has relays fitted, the warn relay will activate. The behaviour of the alarm bell icon will depend on whether latching or non-latching alarms have been configured.</p>	<p>If the measured gas concentration reaches the set-point programmed into the detector for a danger condition, the detector will signal this via a prominent message in the lower status bar. Additionally a flashing alarm bell icon will be displayed. If the detector has relays fitted, the danger relay will activate. The behaviour of the alarm bell icon will depend on whether latching or non-latching alarms have been configured.</p>
15.1.3 Latched Alarm Indication	15.1.4 Resetting From Alarm State
	
<p>If the condition that triggered an alarm response has subsided and the detector's alarms have been set to 'latched', the bell icon will be indicated in inverse colour. If the alarm condition was at warn level, the bell icon will be static. If the alarm condition was at danger level, the bell icon will be flash.</p>	<p>If the detector alarms are set to non-latching, the alarm state will automatically clear once measured gas concentration has dropped below the set-point (including any set hysteresis value). If alarms are set to latched mode, they must be manually cleared once it has been determined that it is safe to do so. To reset the alarms, unlock the system menu and use the Δ soft-key to navigate to the detector status screen.</p>

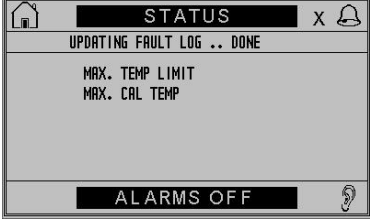
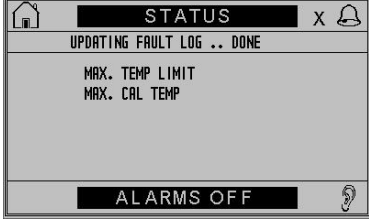
15.1.5 Temporarily Silencing An Alarm	15.1.6 Clearing An Alarm State
	
<p>It is occasionally required to temporarily 'silence' an alarm for conditions where an alarm event has been noted and is being dealt with. D-Guard² allows an alarm condition to be silenced for 10 minutes by operating the soft-key marked with the 'ear' icon (bottom right of the display). For detectors with relay contacts, the relays will be reset to the non-alarm condition for a ten minute duration. For detectors with local sounders and flashing beacons (using the internal relay contacts), these will be switched off for the ten minute period. The inverse displayed bell icon will remain on the display to indicate that an alarm event has occurred. After ten minutes the alarm state will be re-activated if the alarm conditions are still present.</p>	<p>If an alarm has been triggered and the detector is set to latched alarm mode, the alarms can be cleared by using the alarm clear soft-key. This is the upper right bell icon with the cross adjacent to it.</p> <p>Clearing an alarm must only be done by an authorised person.</p> <p>If the conditions that triggered the alarm are still present, the alarm will activate again.</p>

16. Connecting A HART Field Communicator

For D-Guard-2 detectors that are fitted with HART communications, interaction with the detector may be done via a HART master communication device such as a HART field communicator / configurator or a system controller.

HART enabled D-Guard² detectors are fitted with an IP68 rated connector (communications port) to allow connection of a field communicator.

A suitable cable to connect between a standard field communicator and the D-Guard² is available from GasTech.

Connections at the communicator are polarity independent.

To start communications, open the communications port waterproof cap and plug the data connector into the port.

D-Guard² is by default set to polling address 0 and is set for point to point (variable current loop) operation.

D-guard² does not use Device Description type files and will be discovered as a generic device to a field communicator.

Once successful communication has been established, the HART communication icon will start to flash (refer to section 13.1.1).

For complete details regarding D-Guard² HART communications, refer to the D-Guard² HART specification document (This document is available from the GasTech Australia website www.gastech.com.au).

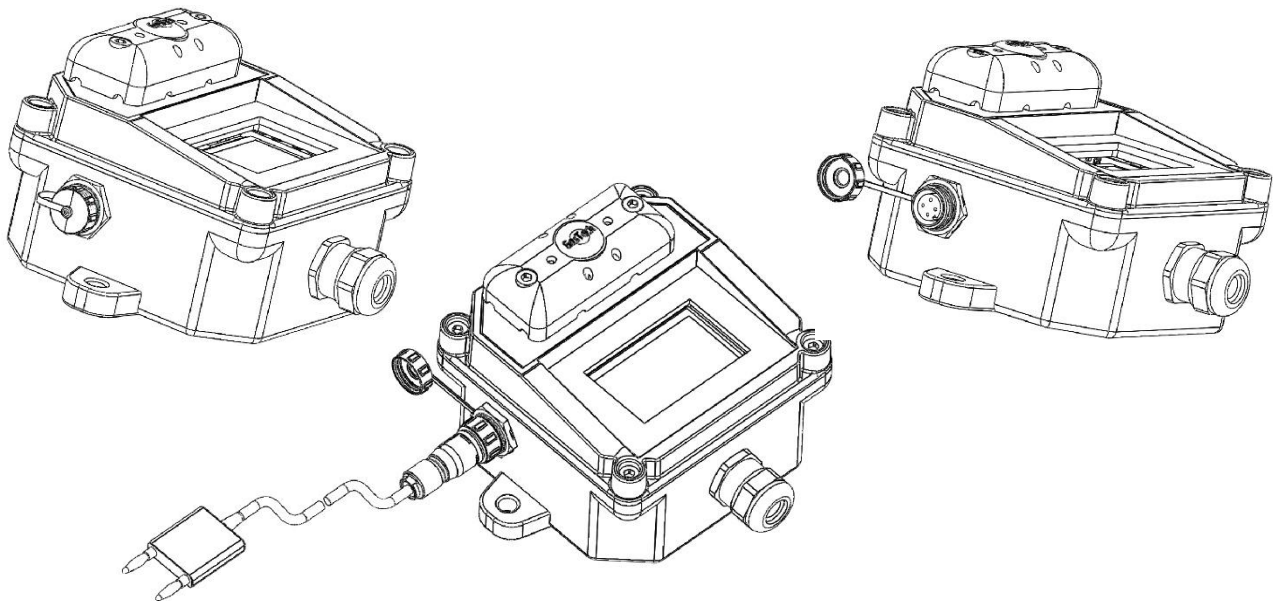

Remove the waterproof cap to access the communications port. Note that the detector is rated IP68 ONLY if this cap or the mating connector are in place. Without the cap or connector fitted rating is IP66 only.

17. Detector Maintenance

Under normal operating conditions, D-Guard² requires minimal maintenance above any scheduled service as set by local site regulations.

17.1. Visual Inspection

Basic visual inspection focuses on looking at the physical installation for signs of damage, water or dust ingress and the condition of cables and labels. Visual inspections may include the need to open cabinets to gain access to some parts of the system. This type of inspection also includes cleaning the fascia and labels that have become obscured by dirt.



NOTE: The detector's fascia panel must only be cleaned using antistatic compatible cleaning materials. Do not clean the detector with cleaning products that may create a build-up of static electricity.

During a Visual Inspection, typical observations would include:-

Check that gas inlet ports are not obstructed by dirt or moisture.

Check that connected cables are intact and free from cuts, abrasions and obvious signs of damage. Verify that cable restraints, including cable glands are in serviceable condition and correctly fitted.

Check system equipment enclosures, cable trays, conduits, wall-boxes etc. for good condition with no signs of physical damage. Verify that sealed cabinets are free from water or contaminant ingress. Check that door seals are in good condition.

Verify that labels fixed to equipment such as enclosures, wall boxes and cables are present and in good condition allowing clear visibility of the information and identification they convey.

Verify that no unauthorised modifications have been carried out on equipment.

17.2. Hands-On (Detailed) Inspections

More detailed inspections would include all of the aspects of visual inspection with additional checks that cover the verification of the integrity of connections, fixtures and fittings. Hands-on inspection may include the use of tools.

Addition to basic visual observations, hands-on checks would typically involve:-

Ensure that the gas inlet port waterproof membranes are intact by removal of the gas port splashguard.

Check the inside of D-Guard² enclosure for signs of moisture or contaminant ingress.

Verify that the detector enclosure lid seal is in good condition.

Re-fit D-Guard² enclosure lid and properly tighten all fixing screws. Verify screw heads are not damaged.

Verify that equipment housings, wall boxes and other mechanical fittings are secured properly. Verify the proper fitting of lids for terminal boxes, the tightness of cable glands and the integrity of wall-box mountings, DIN rails etc.

Verify that all electrical connections are secure with no loose screw terminals.

Verify that DIN rail mounted terminals are firmly secured fitted to their rails.

17.3. Gas sensing cell replacement

As described in section 11.1, electro-chemical sensing cells will eventually diminish in their capacity to accurately detect its target gas. Infra-Red sensors, although more likely to last several years, may become unserviceable due to contamination. Once this occurs, the sensing element will need replacement.

Sensor replacement must only be carried out by GasTech Australia service staff or GasTech Australia appointed agents with the appropriate training.



Sensors must only be replaced with the same type. Fitting substitute brands of sensor may cause the detector to operate unreliably. Fitting sensors of a different type will likely cause the detector to seriously malfunction or become damaged. Substituting sensors for non-GasTech approved parts or incorrect types will void the product warranty. GasTech Australia will not accept liability for any adverse outcomes that may arise as a result of fitting inappropriate sensor types to D-Guard².

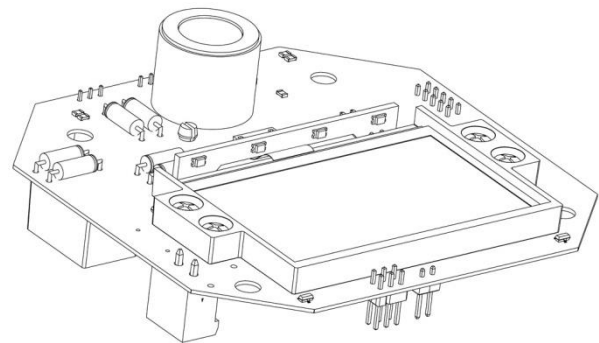
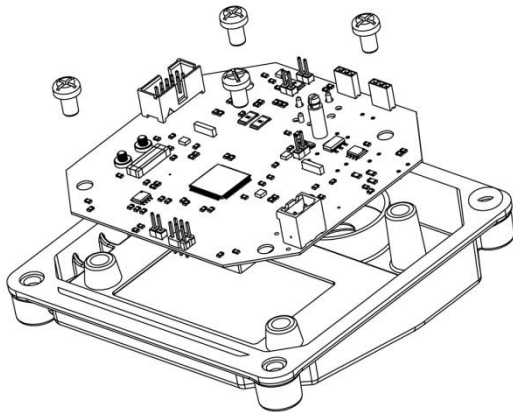

17.3.1 Removing the Detector Main Board

To gain access to the sensor, follow the steps given below.



Note ensure that this is only done by a suitably trained or qualified person.

It is strongly advised to wear an antistatic wristband and use an antistatic mat to place the detector PCB onto when working on replacing the sensor.

- Remove the four lid retaining screws.
- Unplug the power cable from its PCB socket.
- Lay the detector lid face down and observe the four PCB fixing screws.
- Remove the four PCB fixing screws and turn the main board over.



Operate with caution so as not to damage any component or scratch the display. Do not get fingerprints on the display face as these will be difficult to remove.

17.3.2 Replacing the Sensor

- Unplug the old sensor and replace with a new sensor of identical type.
- Reverse the process of disassembly to restore the detector to a fully assembled state.

Once a sensor has been replaced, a full re-calibration of the detector is necessary return the performance to its stated specification. At the same time the cell is replaced, the water repellent membrane that protects the gas entry port, should be inspected and replaced if required.

17.4. General Detector Repair

	<p>With the exception of the gas sensing element and the hydrophobic membrane, D-Guard² contains no user serviceable parts. If a fault develops, the detector must be returned to GasTech Australia for repair. It is essential that no attempt is made to repair a faulty detector by the end user since this may compromise the safety of the unit resulting in potential operational hazards that may endanger the life of personnel.</p>
---	---

17.5. Disposal of D-Guard² Components

	<p>When D-Guard² has reached the end of its service life it must not be treated as general waste.</p> <p>The electro-chemical cells used to detect gas contain substances that could potentially create an environmental hazard.</p> <p>Under no circumstances should the cells be incinerated by the user since they could release toxic fumes.</p> <p>When cells are replaced by GasTech Australia, GasTech Australia will properly dispose of the used items.</p> <p>Disposal of the electronics, enclosure or any ancillary part of the detector must be done in accordance with appropriate local government regulations.</p> <p>By responsibly disposing of D-Guard², you will be helping to minimise the possibility of negative environmental and human impact, which could otherwise be occur through incorrect disposal of this product.</p>
---	--

18. APPENDIX A:

18.1. Output Current Signal - Total Loop Resistance vs Power Supply Voltage

The maximum total current loop load resistance that can be driven by D-Guard² depends on the voltage supply fed to the detector. This total resistance includes all aspects of an installation such as barrier resistance, cable resistance / length and the value of the sense resistor used at any connected controller's input channel.

The operator is advised to account for all of these system resistances and provide a source of power supply that will allow the detector to operate safely with the ability to drive the loop to 22mA (fault signalling).

Incorrect allowance for system resistances and power supply voltages may result in the detector being unable to correctly signal the measured gas concentration.

The graphs below shows the relationship between detector power supply voltage output and maximum loop resistance for both Group I and Group II versions of D-Guard². Note that there are two graphs for each type since the detector can be configured prior to installation to use the display backlight or not. disabling the backlight allows a wider range of supply voltages and loop resistances.

18.1.1 Loop Resistance - D-Guard² With Backlight Disabled - loop at 22mA

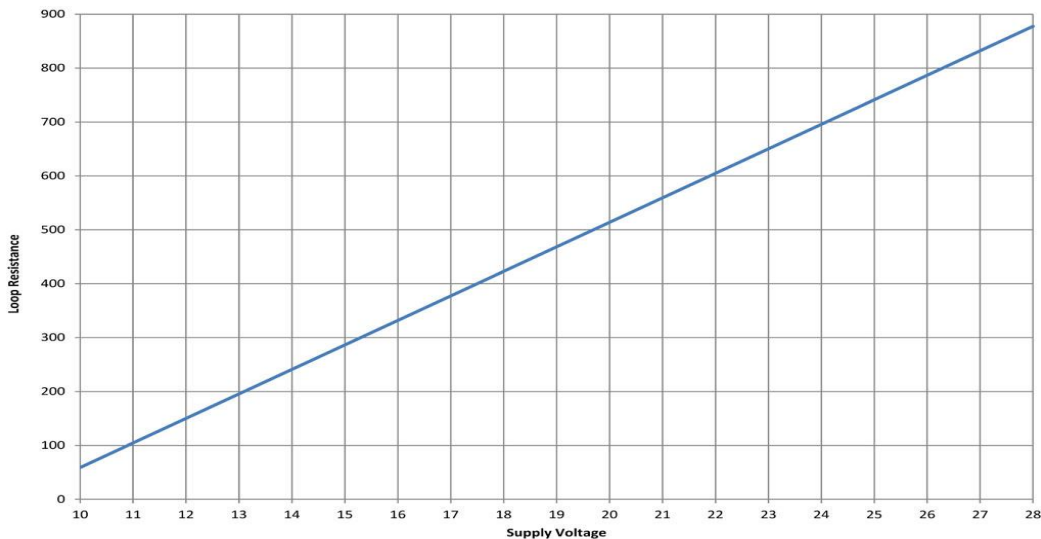

18.1.2 Loop Resistance - D-Guard² With Backlight Enabled - loop at 22mA

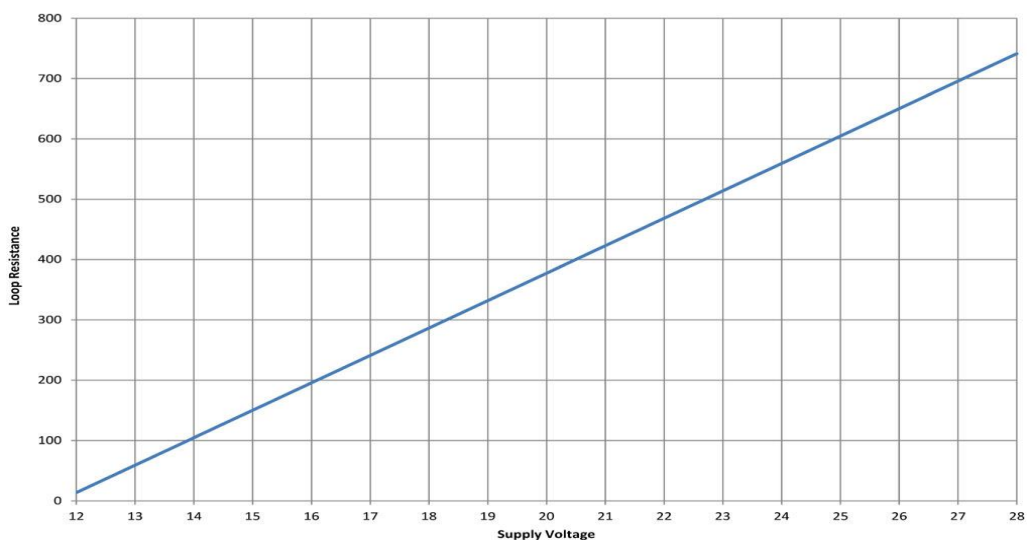

19. APPENDIX B:

19.1. Relay Board and Sounder Options.

The D-Guard²G can be ordered with an optional relay board (D-Guard²R, part number: 65-1080R-xxx) which provides the option for standalone operation.

Additionally, The D-Guard²G can be ordered with an optional relay board and sounder combination (D-Guard²S, part number: 65-1080S-xxx).



Alarm 2 Siren Jumper

Alarm 1 Siren Jumper

19.1.1 Relay Board Functionality

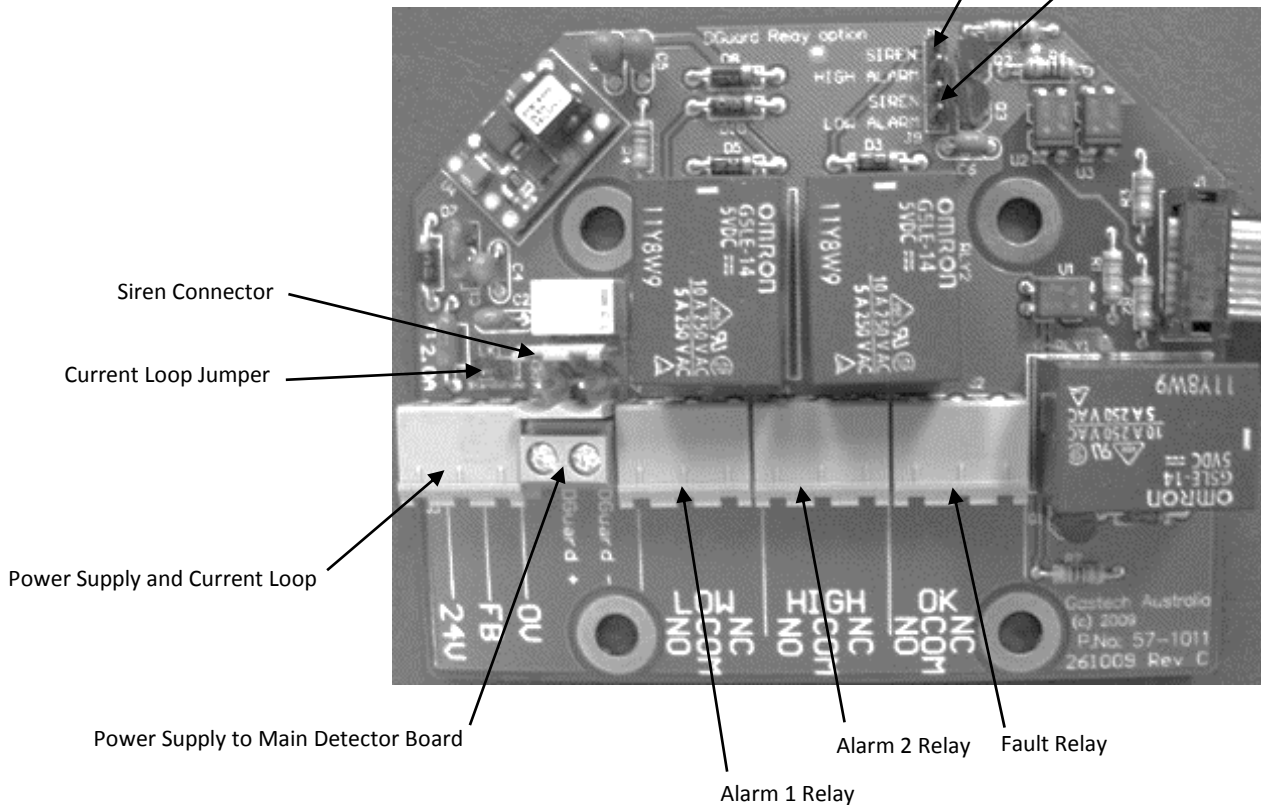

Siren Connector

Current Loop Jumper

Power Supply and Current Loop

Power Supply to Main Detector Board

Alarm 1 Relay

Alarm 2 Relay

Fault Relay

19.1.2 Table of Functions (identified by silk screen legend on relay board and photo annotations)

Function	Description
24V	Supplies power to the relay board and the detector main circuit board. Connect to positive side of the power supply.
FB (feedback)	Current loop output signal (sourcing type output). Connect to an external controller input that has an input shunt sense resistor.
0V	Power supply return. Connect this to negative side of the power supply.
DG+	Detector board positive power supply output. Connect to the detector main PCB supply positive input.
DG-	Detector board negative power supply output. Connect to the detector main PCB supply negative input.
Alarm 1	First alarm relay. Changes state when measured gas level exceeds the alarm 1 threshold setting. NC and NO connections apply to normally de-energised relay settings. For normally energised relays, the function of NC and NO are reversed.
Alarm 2	Second alarm relay. Changes state when measured gas level exceeds the alarm 2 threshold setting. NC and NO connections apply to normally de-energised relay settings. For normally energised relays, the function of NC and NO are reversed.
Fault	Normally energised Fault Relay. De-energises if power to the detector is removed or if detector fault is present.
Loop Jumper	This configures the detector to operate in standalone mode where a system controller is not present
Siren	Connect to the factory fitted Sounder / Strobe on D-Guard²S units.
Alarm 1 siren	Install this jumper to enable the siren when Alarm 1 is active (normally de-energised relay setting only).
Alarm 2 siren	Install this jumper to enable the siren when Alarm 2 is active (normally de-energised relay setting only).

19.2. Relay Board Connections

19.2.1 Current Loop Connection Scheme

Relay Board Connection Current loop configuration

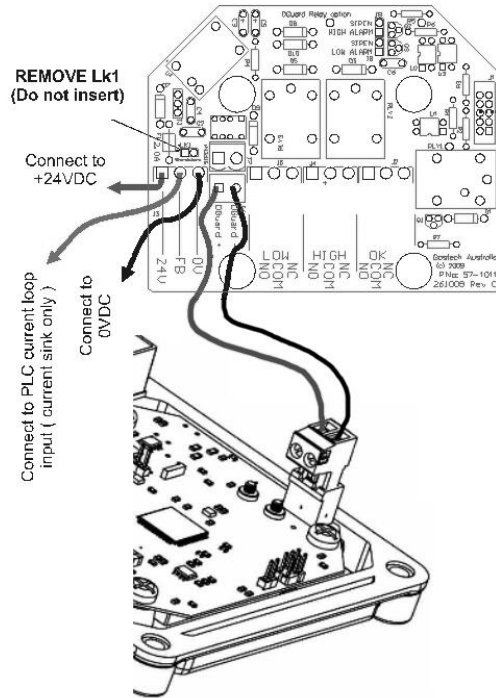

19.2.2 Stand-Alone Connection Scheme

Relay Board Connection Standalone configuration

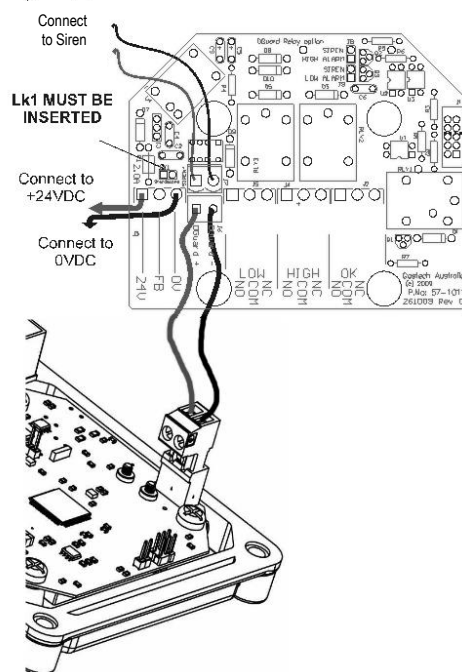

20. APPENDIX C:

20.1. Disabling the Display Backlight

By default, the display backlight is enabled for Group II versions of D-Guard² and disabled for Group I versions. The backlight LEDs, when enabled create a voltage drop of around 3.0V in the power supply fed to the internal electronics. For many applications, this is acceptable and no changes are necessary.

For applications where long cable lengths, large barrier resistances and low power supply voltages are present, it may be required to disable the backlight LEDs to gain additional voltage compliance for the current loop output to function up to 22mA.

Disabling the LEDs gives around 130 Ohms extra available loop resistance at 22mA, or will allow the supply voltage to be operated 3.0V lower for a given loop resistance.

Determining whether the backlight link needs to be fitted requires an understanding of the characteristics of the components of the system into which the detector is installed. If in doubt consult the system designer, plant engineer or other body with knowledge of the system.

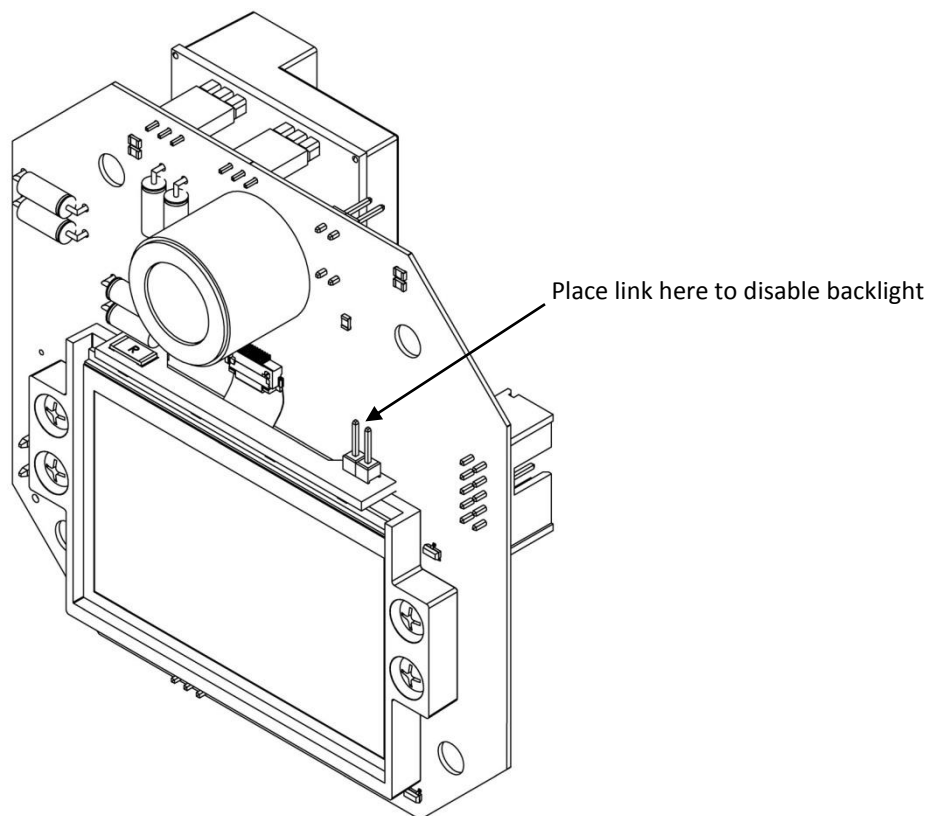

21. APPENDIX D:

21.1. CHEMICAL COMPATIBILITY

When installing D-Guard², it is important to be aware of the possible effects of chemicals on the construction of the detector. Such effects may not be immediately noticeable, but may over time cause significant deterioration of the enclosure. Even relatively small amounts of non-compatible substances can cause such degradation and should be considered. Some examples of material deterioration are:- discolouration, rust-like deposits and distortion of the enclosure shape. Other changes may not be visible, such as the characteristic strength of the enclosure material changing, thus rendering the housing brittle. The following table lists typical performance for the enclosure material for exposure to some common substances, including the gases that the detector may be installed to measure.

The performance of the enclosure materials with exposure to these substances will depend on the nature of the application, therefore the information given below is for guidance only.

Substance / Gas	Reaction	Notes
Ammonia 10%v/v	Severe reaction	PPM levels of ammonia will give no problems
Benzene	Excellent	
Butane	Excellent	
Calcium hyperchlorite	Severe reaction	
Carbon Monoxide	Excellent	
Carbon Tetrachloride	Excellent	
Chlorine	OK	High concentrations of liquid chlorine may cause damage. PPM levels will give no problems.
Diesel Fuel	Excellent	
Ethane	Excellent	
Ethanol	Excellent	
Ethyl Alcohol.	Excellent	
Ethylene Oxide	Severe reaction	PPM levels will give no problems.
Fluorine	Severe reaction	PPM levels will give no problems.
Gasoline	Excellent	
Hexane	Excellent	
Hydrogen Sulphide	OK	Possible discolouration
Jet Fuel	Excellent	
Kerosene	Excellent	
Oxygen	Excellent	
Sulphur Dioxide	OK	
Toluene	OK	

Excellent = no effects on material composition OK = Can be used with possible effects as noted

Severe reaction = likely to become damaged if exposed to high levels for prolonged periods.

22. APPENDIX E:

22.1. Cross Sensitivity - Toxic Sensors

By varying the material construction of the electro-chemical cells, sensors can be optimised towards different gas types along with differing sensitivities. An important point to note however, is that, for any given gas sensing cell type, even though optimised for a particular target gas, there may be sensitivity to other gases. This is known as 'cross sensitivity' and is inherent in the mechanism by which the cells operate. The following table gives an indication of cross sensitivities for each of the D-Guard² detectors. This information is very useful in determining the likelihood of false readings or possible alarm conditions due to the effects of cross sensitivity. Locating a detector in an environment that is likely to contain gases other than the one specifically being measured can cause operational problems.

Table of percentage cross sensitivity for typical D-Guard² gas detector types.

Interfering gas	ppm	D-Guard ² CO	D-Guard ² NH ₃	D-Guard ² H ₂ S	D-Guard ² SO ₂	D-Guard ² ETO	D-Guard ² NO	D-Guard ² NO ₂	D-Guard ² Cl ₂	D-Guard ² O ₂
CO	400	n/a	0	3%	0.5%	40%	0.1%	0	0	-
H ₂ S	20	0	2%	n/a	0	-	60%	-88%	-88%	-
H ₂	400	45%	0	0.6%	0	-	0.1%	0	0	-
SO ₂	20	0	-	15%	n/a	-	4%	-1%	-1%	-
NO ₂	10	0	-	-25%	-100%	-	5%	n/a	100%	-
NO	50	8%	-	0	-110%	-	n/a	0.4%	0.4%	-
C ₂ H ₄	400	52%	-	0.5%	30%	-	-	0	0	-
Cl ₂	10	1%	-	-20%	-38%	-	5%	100%	n/a	-
NH ₃	20	0	n/a	0	0	-	0.1%	0.2%	0.2%	-
CO ₂	5%	0	0	0	0	-	0.1%	0	0	-0.03/% *

As an example:-

400ppm of hydrogen sulphide would produce a response equivalent to 180ppm in a carbon monoxide sensor per the table value of 45% cross sensitivity (0.45 x 400ppm = 180ppm equivalent response).

The actual displayed value and the value transmitted over the current loop will ultimately depend on the actual detector full scale range. Cross sensitivity data relates to the raw signal from the gas sensor before any scaling is applied.

* O₂ sensors do not respond to CO₂, but exhibit a change in sensitivity to Oxygen when exposed to CO₂

22.2. Cross Sensitivity - Infra-Red Sensors

The cross sensitivity for infra-red sensors includes all hydrocarbon gases that share the same absorbance wavelengths. For a detector specified to measure methane (CH₄), a calibration curve that provides a linear response to methane is employed. The sensor will respond to other hydrocarbons but will not necessarily produce an accurate or linear response. For applications designed to monitor methane where multiple hydrocarbons may be present, allowance must be made for the possibility that the detector will read higher than expected due to the increase in sensor response to the multiple gases.

23. APPENDIX F:

23.1. Environmental Effects on Detector Performance

Environmental changes in temperature, pressure and humidity can alter the performance of the sensing elements within D-Guard².

23.2. Temperature

The use of inherently stable electronics and built-in software routines provide compensation for static or slow moving changes in ambient temperature. However, rapid changes in temperature, if severe enough, can impart transient shifts in the detector's output signal. The effect is generally low level, but in systems where alarm points are set close to the normal zero operating point, false alarms could occur. For this reason, wherever possible, locate the detector out of direct sunlight or other sources of heat that may be cycled.

23.3. Pressure

Static or slow rates of change of atmospheric pressure will have little effect on the performance of D-Guard² Toxic gas detectors. Transient pressure changes can however cause spurious responses generally lasting for tens of seconds. Oxygen sensors are more severely affected than other 'electro-chemical' type detector types. Infra red sensors will show a response to pressure changes that is described by the ideal gas laws. The molar concentration of a gas (n) is proportional to pressure according to $n = pv / rt$, where p = pressure, v = volume, r = ideal gas constant and t = absolute temperature.

Detectors will respond to both positive and negative pressure transients but the response in a toxic gas sensor to positive transients is about 3 times greater than for negative transients. Infra-Red sensors will respond equally to positive and negative pressure shifts. Detectors should not be located in sealed rooms with doors that may be opened and closed rapidly, or in locations where ventilation systems can create pressure pulses.

23.4. Humidity

The electrochemical cells used in D-Guard² detectors use an aqueous sulphuric acid electrolyte. This electrolyte remains in an equilibrium state of sulphuric acid to water content at a relative humidity of 60%. If the detectors are subject to a relative humidity greater than 60%, then the electrolyte will absorb water. Conversely if the exposure is to a relative humidity less than 60%, water will be lost from the electrolyte.

For exposure to dry atmospheres where water is lost from the electrolyte, the cell will eventually 'settle' and adopt the new conditions as its operating point. Prolonged exposure to dry atmospheres will eventually prevent the cell from operating and will present a fault condition from the D-Guard² detector. Normal sensor operation can be restored by exposure to atmospheres within the 15% to 90% RH range. Re-calibration of the detector will however be required.

For exposure to a very high relative humidity, the cell may not be able to accommodate the increased water volume through absorption, and may leak. Once leakage has occurred, the cell is deemed to have failed and will require replacement.

It is important that the D-Guard² detectors are installed and operated in conditions that meet the product specification of 15% to 90% RH per the product specification.

24. APPENDIX G:

24.1. System Menu Map

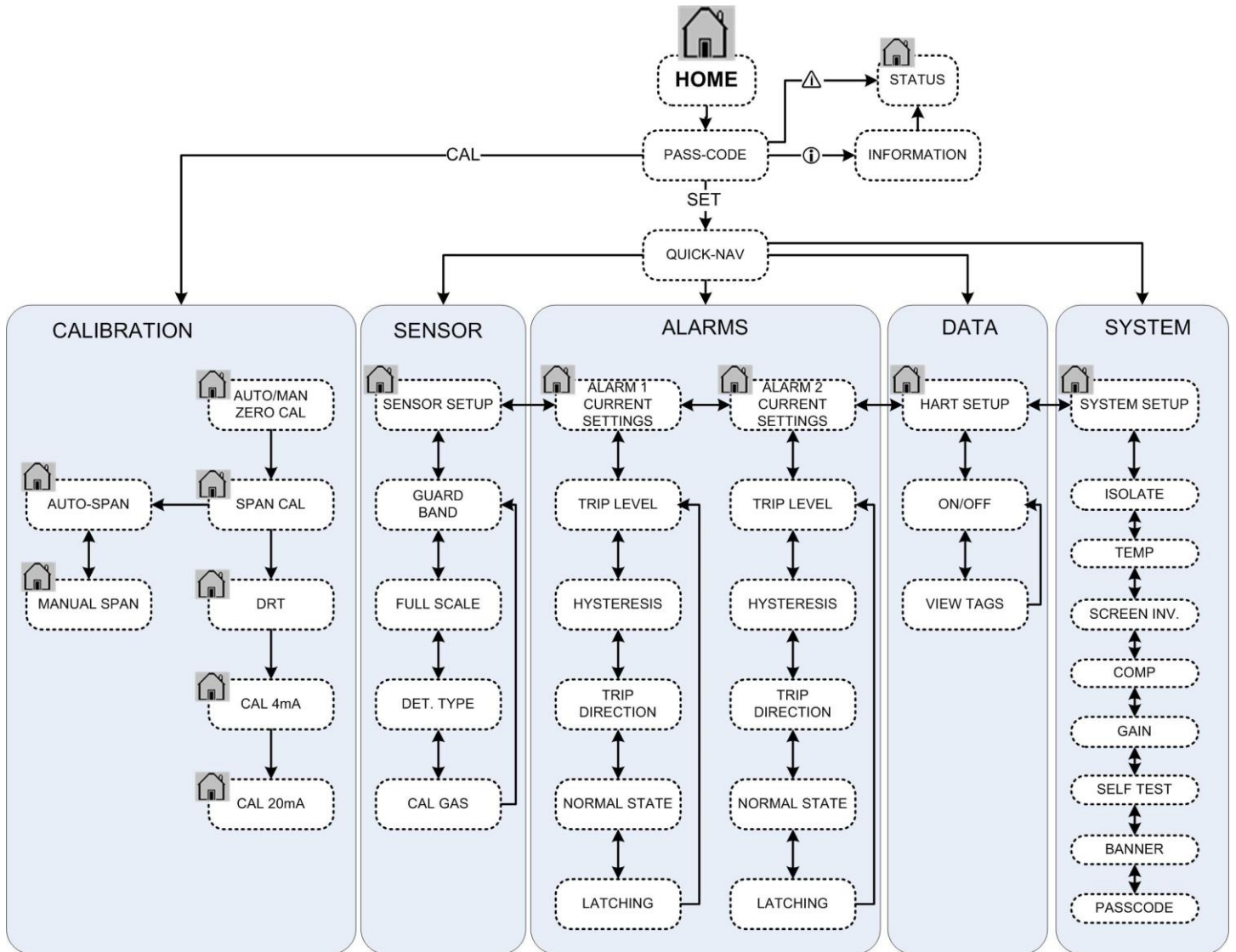

25. APPENDIX H:

25.1. Performance Specifications

25.1.1 General Specifications

Parameter		Description / Conditions	Limits		Units
			Min	Max	
GS-1	Measurement Techniques	Electro-Chemical Cell, Infra-Red.	-	-	-
GS-2	Target Gas	Depends upon model (see table 2 – gas types and ranges).	-	-	-
GS-3	Full Scale Ranges	Depends upon model (see table 2 – gas types and ranges).	-	-	-
GS-4	Measurement Accuracy	Refer to Sensor Performance tables.			
GS-5	Maximum Loop Current	Under any condition of operation or fault.	-	30	mA
GS-6	Minimum Supply Voltage at 20mA	Minimum operating voltage at detector	13.0	-	VDC
GS-7	Maximum Loop Resistance.	At Vpsu 28V with backlight (see graph).	-	720	Ohms
GS-8	Absolute Maximum Supply Voltage	Maximum supply voltage no damage to electronics (All versions)	-	30	VDC
GS-9	Loop Error Signal (low – electronics fault)	Detected faults within hardware or software	-	3.3	mA
GS-10	Loop Error Signal (low – sensor fault)	IR Head failure	-	3.3	mA
GS-11	Display	Graphical display 400 pixels by 240 pixels. High contrast type	-	-	-
GS-12	Temperature Sensor	Semiconductor temperature sensor	-20	+110	°C
GS-13	Pressure sensing – Ambient (optional)	MEMS based absolute value. Instrument body and head.	50	115	kPa
GS-14	Sensor keep-alive battery (optional)	3.6V 55mAH lithium coin cell. PCB mounted 'encapsulated'			
GS-15	Digital Communications	HART 7.0 over 2-wire current loop (refer separate specification)			
GS-16	Relays (Optional for non-Ex variants)	2 x Single Pole Change Over for warn and alarm + 1 fault relay			
GS-17	Relay max. contact carry current	Non-Switched current handling (Carry Current)	-	10	A
GS-18	Relay maximum contact power	Resistive		1,200	VA
GS-19	Relay contact voltage rating switching).	Switched contact voltage limit	-	240/30	V AC/DC
GS-20	Relay healthy operating state.	Normally energised / Normally de-energised (configurable)			
GS-21	Relay state changes	User set Gas Level, system fault.			
GS-22	Sounder Output	Sound pressure level	-	98	dB
GS-23	Strobe Output	Flashing or Steady illumination	-	-	-

25.1.2 Methane Detector Specifications

Parameter	Specification
MSS-1	Gas Type Methane INFRA-RED
MSS-2	Detection ranges 0 – 5% v/v, 0 – 100% v/v
MSS-3	Sensor technology NDIR Infra-Red
MSS-4	Sensor Size 20mm diameter
MSS-5	Sensor Life >10 Years
MSS-6	Calibration method 2 point, zero, full-scale
MSS-7	Accuracy (scale and linearity) To AS2290.3, ANZ60079.29 and AS4641
MSS-8	Stated accuracy temperature limits 0°C to +40°C
MSS-9	Operating temperature limits -10°C to +40°C
MSS-10	Operating humidity range 0% to 98%
MSS-11	Operating pressure range 80kPa to 120kPa
MSS-12	Humidity/Condensation effects Negligible
MSS-13	Long term drift Zero: Less than specified by 60079.29.1 Sens: Less than specified by 60079.29.1
MSS-14	Cross Sensitivity CO: none. NO: none. H ₂ : none
MSS-15	Response time T90: <=22 seconds
MSS-16	Environmental protection Replaceable hydrophobic membrane (part of enclosure).

25.1.3 Carbon Dioxide Detector Specifications

Parameter		Specification
CSS-1	Gas Type	Carbon Dioxide INFRA-RED
CSS-2	Detection ranges	0 – 1.5% v/v
CSS-3	Sensor technology	NDIR Infra-Red
CSS-4	Sensor Size	20mm diameter
CSS-5	Sensor Life	>10 Years
CSS-6	Calibration method	2 point, zero, full-scale
CSS-7	Accuracy (scale and linearity)	To AS2290.3, ANZ60079.29 and AS4641
CSS-8	Stated accuracy temperature limits	0°C to +40°C
CSS-9	Operating temperature limits	-10°C to +40°C
CSS-10	Operating humidity range	0% to 98%
CSS-11	Operating pressure range	80kPa to 120kPa
CSS-12	Humidity/Condensation effects	Negligible
CSS-13	Cross Sensitivity	CO: none. NO: none. H ₂ : none
CSS-14	Response time	T90: < 30 seconds
CSS-15	Environmental protection	Replaceable hydrophobic membrane (part of enclosure).

25.1.4 Electro-Chemical Detector Specifications * Cell dependant

Parameter		Specification
TSS-1	Sensor technology	Amperometric electro-chemical cell
TSS-2	Sensor Size	20mm diameter
TSS-3	Sensor Life	Typically 2 Years to 80% of 'new' output signal
TSS-4	Calibration method	2 point, zero and full-scale
TSS-5	Accuracy (scale and linearity)	To AS2290.3, ANZ60079.29 and AS4641
TSS-6	Stated accuracy temperature limits	-20°C to +40°C
TSS-7	Operating temperature limits	-20°C to +50°C
TSS-8	Operating humidity range	15% to 90%
TSS-9	Operating pressure range	80kPa to 120kPa
TSS-10	Pressure effects	Negligible for steady state above or below 101.3kPa
TSS-11	Humidity effects (uncompensated)	Negligible for steady state above or below 60% RH
TSS-12	Long term drift	Zero: Less than 0.01ppm to 0.5ppm per 12 months (cell type and environment condition dependant) Sens: Typically less than 3% of scale per 12 months
TSS-13	Cross Sensitivity	Refer to Specific sensor data sheet.
TSS-14	Typical response Time t50	<=10 seconds from step change input *
TSS-15	Typical response Time t90	< 25 seconds from step change input *

25.1.5 Mechanical & Environmental Specifications

Parameter	Description / Conditions	Limits		Units
		Min	Max	
MS-1	Enclosure material	Antistatic carbon filled Delrin		
MS-2	Enclosure construction	Injection Moulded		
MS-3	Enclosure wall section	6.5	7	mm
MS-4	Enclosure IP Rating	IP66 & IP67 / IP68 (G and R versions) IP65 (S version)		
MS-5	Enclosure Lid Retainer	Not Retained		
MS-6	Enclosure Lid Fixing	Four corner screws (4mm Hex Heads)		
MS-7	Cable Glands	Provision for up to 3 x 20mm nylon or chrome plated steel		
MS-8	Enclosure Footprint	As per present D-Guard Detector.		
MS-9	Storage Temperature	-20	60	°C
MS-10	Operating Temperature	-20	55	°C
MS-11	Operating Humidity	15	90	%rh