

# HONEYWELL BW™ ICON AND BW™ ICON+ QUICK REFERENCE GUIDE



Honeywell

# HONEYWELL BW™ ICON AND BW™ ICON+ PORTABLE MULTIPLE GAS DETECTORS

The Honeywell BW™ Icon & BW™ Icon+ gas detectors warn of hazardous gas at levels above user-defined alarm setpoints.

These detectors can monitor up to four gases at a time. Refer to the Honeywell BW™ Icon User Manual for the full list of gases.



## USER INTERFACE



**Alarm One** - Shows when alarm one is breached and gas highlighted next to sensor



**Alarm Two** - Shows when alarm two is breached. Alarm two will overwrite any alarm one status

TWA

**Time Weighted Average** - Settable in Safety Suite DC for each toxic sensor

STEL

**Short Term Exposure Limit** - Settable in Safety Suite DC for each toxic sensor



**Bump** - Shows when bump is due and you can configure to have a count down



**Calibration** - Shows when calibration is due and you can configure to have a count down



**Battery status** - Shows battery status and when on charge will show charging status



**Bluetooth®** - All devices have Bluetooth, double click to enter menu for search mode

## WHAT'S IN THE BOX

- Honeywell BW™ Icon gas detector
- Battery (factory-installed)
- USB charger
- 1 Calibration cap
- Quick Reference Guide
- Tubing
- 1 Klick Fast stud

# OVERVIEW

- 1 LED Alarm
- 2 IntelliFlash
- 3 Display
- 4 Button
- 5 Beeper
- 6 Sensor
- 7 Clip
- 8 Battery
- 9 Charging Port

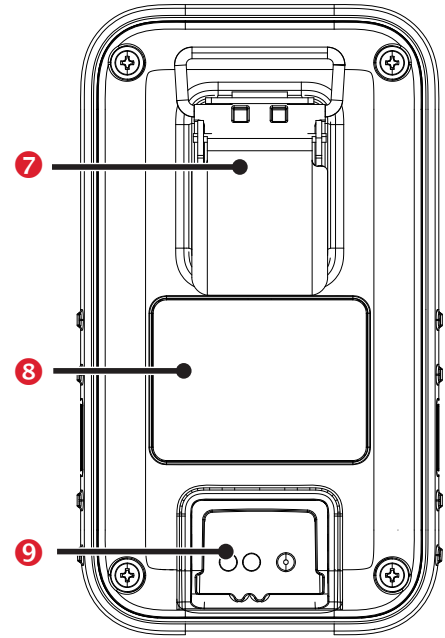
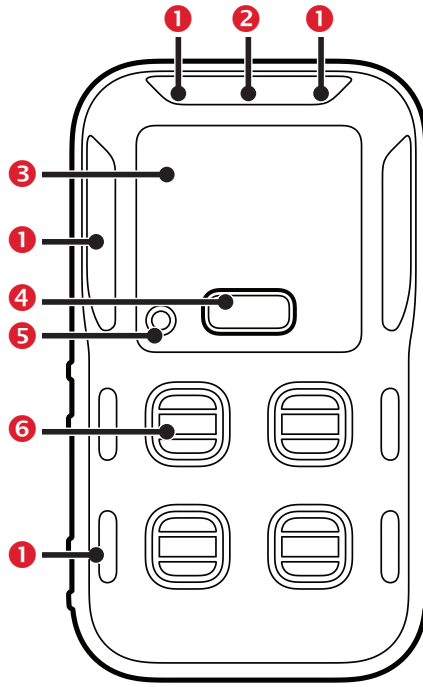

## COMMON DEVICE OPERATIONS

<b>Power On</b>	4-second hold
<b>Power Off</b>	4-second hold
<b>Enter and Exit Menus</b>	Double-press
<b>Select Next</b>	Single-press
<b>Initiate Selected</b>	3-second hold
<b>Acknowledge Latched Alarm</b>	1-second hold

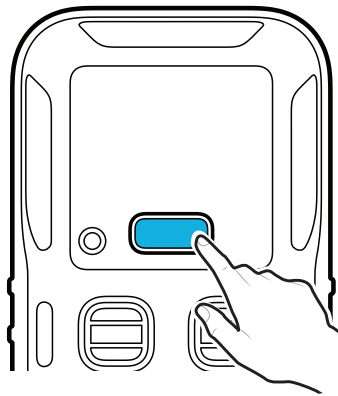

## IMPORTANT

Read the User Manual for complete information on the BW™ Icon operation.

## BUMP TEST AND CALIBRATION VIA A MOBILE DEVICE

### 1 Turn on the BW™ Icon

Place the cap over the detector, and then press down on both tabs to snap it into place



### 2 Attach the hose

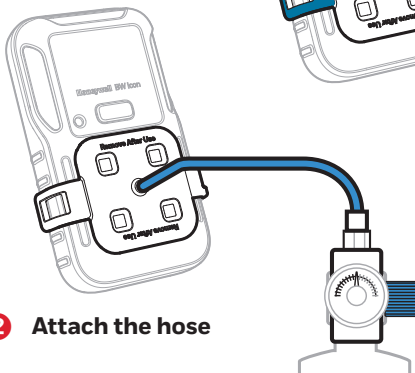

### 3 In your mobile device, open the **Device Configurator** app



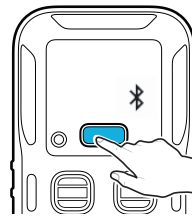

### 4 In your BW™ Icon:

- Double press to enter the menu
- Single press until the BLE icon  is displayed
- Hold press 3 secs to initiate the pairing mode



### 5 In the Device list screen from the **Device Configurator** app, select the BW Icon Serial Number to start pairing. The upper LED and the BLE icon will light in green after pairing success

### 6 In your Mobile device:

- Tap on the Menu button 
- Select Remote Calibration or Bump 
- Follow on-screen instructions

### 7 The process is complete when the results are displayed on your mobile device. You can now remove the cap by pulling on the tabs

# SAFETY CERTIFICATIONS

## IECEX: IECEX SIR 20.0020X

Ex ia op is I Ma Ex ia op is IIC T4 Ga,  $-40^{\circ}\text{C} \leq \text{Tamb} \leq 60^{\circ}\text{C}$  (with IR sensor installed)  
Ex ia I Ma Ex ia IIC T4 Ga,  $-40^{\circ}\text{C} \leq \text{Tamb} \leq 60^{\circ}\text{C}$

## North America: CSA 20CA80028223X CSA C22.2 No.60079-29-1 UL60079-29-1

Class I, Division 1, Group A,B,C,D, T4;  
Class I, Zone 0, AEx ia op is IIC T4 Ga; Ex ia op is IIC T4 Ga (With IR sensor installed)  
Class I, Division 1, Group A,B,C,D, T4;  
Class I, Zone 0, AEx ia IIC T4 Ga; Ex ia IIC T4 Ga

## ATEX: Sira 20ATEX2012X

ⓈI M1 Ex ia op is I Ma,  $-40^{\circ}\text{C} \leq \text{Tamb} \leq 60^{\circ}\text{C}$  (with IR sensor installed)  
ⓈII 1G Ex ia op is IIC T4 Ga,  $-40^{\circ}\text{C} \leq \text{Tamb} \leq 60^{\circ}\text{C}$  (with IR sensor installed)  
ⓈI M1 Ex ia I Ma,  $-40^{\circ}\text{C} \leq \text{Tamb} \leq 60^{\circ}\text{C}$   
ⓈII 1G Ex ia IIC T4 Ga,  $-40^{\circ}\text{C} \leq \text{Tamb} \leq 60^{\circ}\text{C}$   
RED: RE-D Directive 2014/53/EU  
EMC: Directive 2014/30/EU  
ROHS Directive (EU) 2015/863 amending 2011/65/EU

**IP:** IP66, IP68 (1.2 meters for 45 minutes)

Contains FCC ID: SU3RMBLED  
Contains IC: 20969-RMBLED  
CAN ICES-3(A)/NMB-3(A)

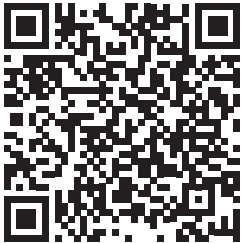

## Europe, Middle East, Africa

Life Safety Distribution GmbH  
Toll-Free 00800 333 222 44  
Middle East +971 4 450 5800  
Middle East +971 4 450 5852  
(Portable Gas Detection)  
gasdetection@honeywell.com

## Americas

Honeywell Analytics  
Distribution Inc.  
Tel: +1 847 955 8200  
Toll free: +1 800 538 0363  
detectgas@honeywell.com  
gasdetection@honeywell.com  
www.honeywellanalytics.com

## Asia Pacific

Honeywell Analytics Asia Pacific  
Tel: +82 (0) 2 6909 0300  
India Tel: +91 124 4752700  
analytics.ap@honeywell.com

## Technical Services

EMEA: HAexpert@honeywell.com  
US: ha.us.service@honeywell.com  
AP: ha.ap.service@honeywell.com



## CAUTION

- The detector is a personal safety device. It is your responsibility to respond properly to the alarm.
- For safety reasons, this equipment must be operated and serviced by qualified personnel only.
- The lithium battery in this product presents a risk of fire, explosion, and chemical burn if misused. Do not disassemble, incinerate, or heat above 212°F (100°C). Batteries exposed to heat at 266°F (130°C) for 10 minutes can cause fire and explosion. Batteries must only be charged in a safe area free of hazardous gas.
- Deactivating the detector by removing the battery pack may cause improper operation and harm the detector.
- Use only Honeywell approved battery chargers such as the vehicle Charger.
- Do not use the apparatus if it is damaged. Inspect the apparatus before use. Look for cracks and missing parts.

THE  
FUTURE  
IS  
WHAT  
WE  
MAKE IT

**Honeywell**