

TVOC



Instrument User Manual V4.6



Register your instrument online to receive your extended warranty.

Unrivalled Detection.

www.ionscience.com

Register your instrument online for extended warranty

Thank you for purchasing your Ion Science instrument.

The standard warranty of your instrument can be extended to up to five years on PhoCheck Tiger and two years on other Ion Science instruments.

To receive your extended warranty, you must register your instrument online within one month of purchase (terms and conditions apply.)

Visit www.ionscience.com/instrument-registration

Declaration of conformity

Manufacturer: Ion Science Ltd, The Way, Fowlmere, Cambridge, SG8 7UJ, UK

Product: TVOC

Product Description: An intrinsically safe fixed continuous monitor comprising of a photo-ionisation detector for detecting and measuring volatile organic compounds with a 4-20mA output

Directive 2014/34/EU ATEX

Identification:  II 2G EEx ia IIC T4 (-20°C ≤ Ta ≤ +50°C)
Notified Body: Baseefa Ltd, 1180, Buxton, UK

Identification:  II 3G Ex nA IIC T4 (-40°C < Ta < +50°C)
 Ion Science Ltd Self certified EC Type Examination Certificate(s)

Baseefa05ATEX0277 latest supplement Baseefa05ATEX0277/2 issued 24th November 2008

Ionscience09849 Examination certificate issued 4th September 2009
 Ref Ion Science Cert Report 849237, 849242

International Standards

IECEX BAS 06.0057 latest revision no.1 issued 20th November 2008
 Ref Baseefa Cert Report 05(c)0423, 06(c)0614, 08(c)0578
 Ex ia IIC T4 (-20°C Ta + +50°C)

Standards

BS EN 60079-0:2006 Electrical Apparatus for Potentially Explosive Atmospheres – General Requirement

BS EN 60079-11:2007 Explosive Atmospheres - Equipment Protection by Intrinsic Safety 'i'

BS EN 60079-15:2007 Explosive Atmospheres - Equipment Protection by other means 'n'

BS EN 61010-1:2010 Safety requirements for electrical equipment for measurement, control and laboratory use – General requirements

Directive 2014/30/EU Electrical Equipment – Electromagnetic Compatibility (EMC)

EN61000-6-3:2007 Class 1 (light industrial and domestic) Electromagnetic Compatibility (EMC) Generic standards. Emission standard for residential, commercial and light industrial environments

EN50270:2010 Electromagnetic compatibility. Electrical apparatus for the detection and measurement of combustible gases, toxic gases or oxygen.

Other Standards

BS EN ISO 9001:2008 Quality Management Systems – Requirements

BS EN 80079-34:2011 Potentially Explosive Atmospheres – Application of Quality Systems

On behalf of Ion Science Ltd, I declare that, on the date this product accompanied by this declaration is placed on the market, the product conforms to all technical and regulatory requirements of the above listed directives.

Name: Mark Stockdale

Position: Technical Director

Signature:



Date: 29th April 2016

Contents

Declaration of conformity	3
Statements	5
Responsibility for use	5
Quality assurance	5
Disposal	5
Legal Notice	5
Introduction to TVOC	6
Packing list	8
Standard TVOC instrument	8
TVOC Calibration Tool Kit	8
TVOC setup	9
Selector Pins	9
Duty Cycle	10
Installation	11
Location	11
Cable and gland requirements	11
Dimensions for mounting	12
Power requirements	13
Initial calibration	15
Operation	16
Start Up	16
Adjusting the Duty Cycle	16
LED's	17
Selector pins	17
Calibration mode	17
Calibration gases	17
Calibration routine	18
Setting the ZERO	18
Setting the gas concentration (The actual value that the calibration has been supplied at)	19
Setting the SPAN	19
Maintenance	21
Cleaning / replacing the lamp	21
Fuse rupture and replacement	23
Lamp Warranty Statement	23
System recommendations	24
Remote area monitoring	24
Gas sample systems	24
Instrument warranty and service	26
Warranty	26
Service	26
Contact details	26
Diagnostics	27
F4 errors	28
Technical specifications	30
Manual log	31

Statements

Responsibility for use

TVOC detects a large range of gases, which are potentially dangerous from both a poisoning and/or an explosive perspective. TVOC has a number of selectable features allowing the detector to be used in a variety of applications. Ion Science Ltd can accept no responsibility for the incorrect adjustment of features that cause harm or damage to persons or property. It is the users' responsibility to respond appropriately to the readings delivered.

Inadequate performance of the gas detection equipment described in this manual may not necessarily be self-evident and consequently equipment must be regularly inspected and maintained. Ion Science recommends that personnel responsible for equipment use institute a regime of regular checks to ensure it performs within calibration limits, and that a record be maintained which logs calibration check data. The equipment should be used in accordance with this manual, and in compliance with local safety standards.

Warning

1. Substitution of components may impair intrinsic safety and result in unsafe conditions.
2. For reasons of safety, TVOC must only be operated and serviced by qualified personnel.
3. Please read and understand this user manual fully before installing, operating or servicing TVOC.

Quality assurance

TVOC has been manufactured in compliance with ISO9001:2008, which ensures that the equipment supplied to our customers has been designed and assembled reproducibly, from traceable components, and leaves Ion Science calibrated to stated standards.

Disposal

Dispose of TVOC and its components in accordance with all local and national safety and environmental requirements. This includes the European WEEE (Waste Electrical and Electronic Equipment) directive. Ion Science Ltd offers a take back service. Please contact us for more information.

Legal Notice

Whilst every attempt is made to ensure the accuracy of the information contained in this manual, Ion Science accepts no liability for errors or omissions, or any consequences deriving from the use of information contained herein. It is provided "as is" and without any representation, term, condition or warranty of any kind, either express or implied. To the extent permitted by law, Ion Science shall not be liable to any person or entity for any loss or damage which may arise from the use of this manual. We reserve the right at any time and without any notice to remove, amend or vary any of the content which appears herein.

Introduction to TVOC

TVOC is a fixed continuous monitor for the detection and measurement of total volatile organic compounds, which can be dangerous from both a poisoning and explosive perspective. Total VOC's are detected using PID (Photo ionisation detection) technology.

TVOC has a number of user selectable features which define its operation and will be application dependent. The user can define the detection ranges or 0.01 - 10ppm, 0.1 – 100 ppm or 1 – 1,000 ppm (Default); detection units, either ppm or mg/m³; and the duty cycle time i.e. the frequency that the instrument takes a measurement. Duty cycles are explained in more detail under TVOC set up, and Operation.

IMPORTANT: TVOC can be calibrated on alternative gases to Isobutylene however to ensure TVOC remains within specification, the correct concentration for the alternative gas must be chosen. Example: Benzene gas has a response factor of 0.5 which means only half as much concentration is required to produce the equivalent to Isobutylene.

The ideal gas / concentrations used to set the calibration SPAN are shown below:-

	Lower limit	Upper limit	
10 ppm range	8 ppm	12 ppm	Isobutylene equivalent
100 ppm range	90 ppm	110 ppm	Isobutylene equivalent
1,000 ppm range	90 ppm	110 ppm	Isobutylene equivalent

How to calculate alternative concentration of gases for gases other than Isobutylene:-

Calibration Gas	Ideal response for Isobutylene	Response factor	Ideal calibration gas concentration
Benzene	100	x 0.5	= 50 ppm
Isoprene	100	x 0.7	= 70 ppm
Isobutylene	100	x 1.0	= 100 ppm
Carbon disulfide	100	x 1.4	= 140 ppm
Ethyl acrylate	100	x 2.0	= 200 ppm

For other gas response factors please refer to the Ion Science web site or contact Ion Science Ltd.
<http://www.ionscience.com/GasSearch/tabid/87/Default.aspx>

WARNING: Ignoring these guide lines may result in calibration failure, loss of resolution or loss of range.

The default settings of TVOC are:

Detection range	-	1 – 1000 ppm
Units	-	ppm
Signal update	-	60 seconds

TVOC gives a continuous 4-20 mA output which can be integrated into a DCS control system to give an indication of VOC levels in the operating environment. Note the 4-20 mA output must be externally powered with 8-35 V.

In addition to the 4-20 mA output TVOC has an LCD display showing gas concentration and 4 colour LED's. LED functions are as follows:

Green	- is an indicator of TVOC's working status
Red	- is the fault indicator
Yellow x 2	- are calibration status indicators

Please see Calibration for more information on LED status.

Introduction to TVOC

For installation requirements please refer to Installation and Technical Specification of this manual. Before attempting an installation, please fully read and understand this user manual, and for hazardous area (IS) installations please also refer to the TVOC Intrinsically safe certificate for further details.

The TVOC safety rating permits its deployment in all hazardous areas of the quoted (or less demanding) rating. For detail please refer to the marking on your instrument (found on the front main label). As of 1st of October units will be manufactured with two protection concepts applied by separate certifications. Intrinsic safety (ia) and Non sparking (nA). All units manufactured up to that date will only have intrinsic safety.

a) Intrinsic Safety (ia) permits the deployment in areas where explosive gases (of group IIA, IIB and IIC) are intermittently present (zone 1) with an ambient temperature range of -20 to 50°C. Intrinsically safe installations will require the use of safety barriers and appropriate wiring.

b) Non sparking (nA) permits deployment in areas where explosive gases (of group IIA, IIB, IIC) are unlikely but possible (Zone 2) with ambient temp range of -20°C to 50°C. Non sparking installations do not require safety barriers however the maximum working voltage should be strictly adhered to as a matter of safety. As no safety barriers are required there is complete flexibility on the implementation of a three wire system.

TVOC does require regular calibration onsite please see the Calibration section for more information. TVOC calibration mode is accessed via a magnetic on site switch system.

Packing list

All items of equipment shipped by Ion Science Ltd are packed in suitable containers and enclosed in a shock absorbing filling which affords a considerable degree of protection against physical damage.

Contents should be carefully removed and checked against the packing list. Any discrepancies between the contents and the packing list must be reported to Ion Science Ltd within ten days of receipt of shipment. Ion Science cannot be held responsible for shortages not reported with in the period.

Standard TVOC instrument

Item	Description	Qty
1.	TVOC instrument	1
2.	Cable gland M20 (Intrinsically Safe Certified)	2
3.	Blanking plug M20 intrinsically (Intrinsically Safe Certified)	1
4.	TVOC Manual	1

TVOC Calibration Tool Kit

Item	Description	Qty
1.	Calibration magnet	1
2.	Calibration adaptor	1
3.	Calibration connector	1
4.	Aspirator	1
5.	Carbon filter	1
6.	Allen keys	1

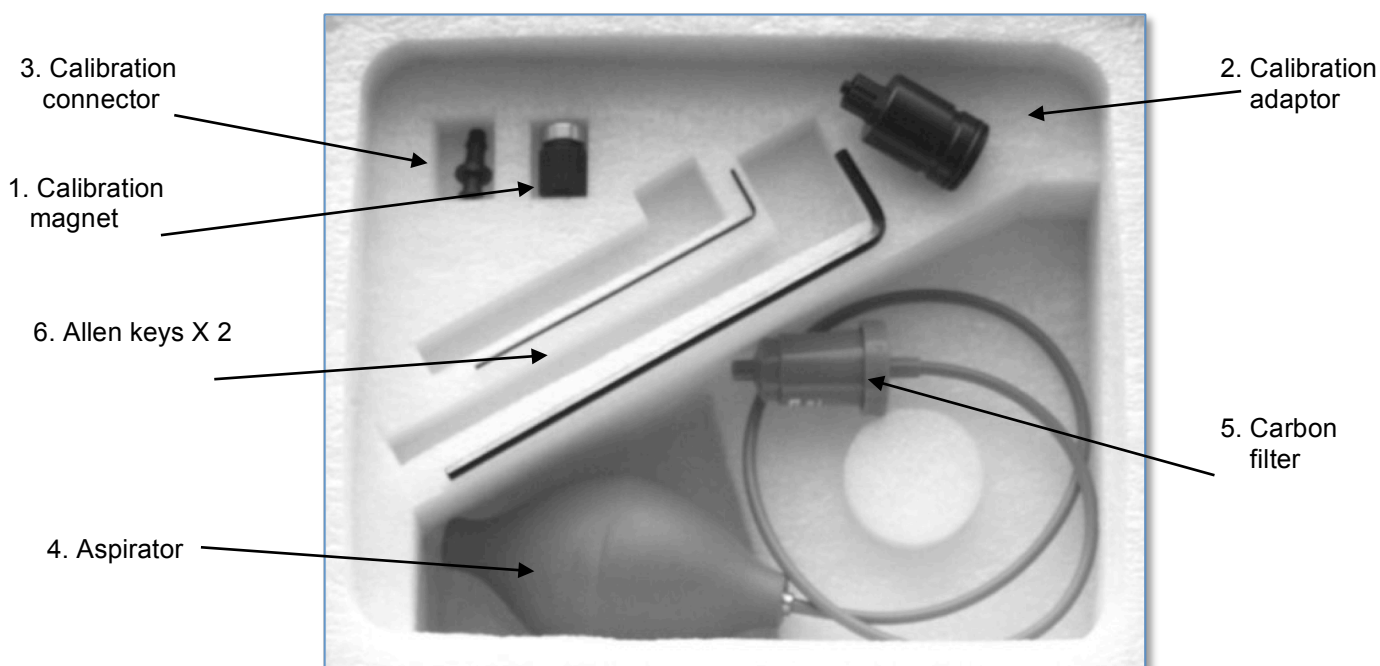

Diagram 1

TVOC setup

Selector Pins

TVOC has a number of settings that can be selected by the user via a row of four selector pins mounted on the reverse side of the main PCB. Diagram 2 shows the location of the functional selector pins labelled - A, B, C & D.

The selector pins absence or presence determines the chosen setting.

TVOC is shipped with all four selector pins fitted as shown in diagram 3.

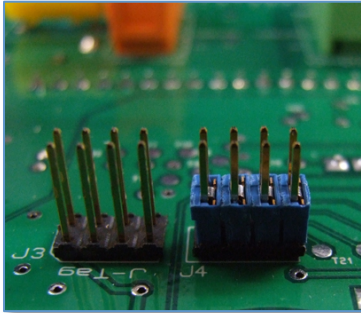

Diagram 3

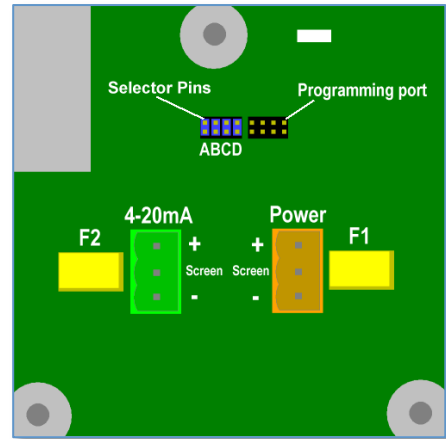

Diagram 2

Diagram 4 shows the removal of 1 selector pin.

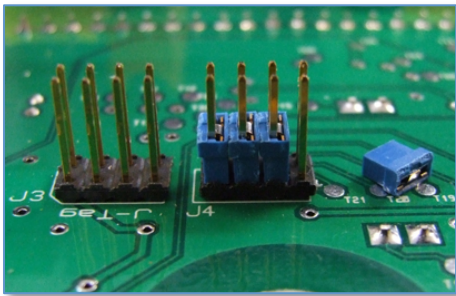

Diagram 4

The following table shows the selector pin combinations and the corresponding function.

✓ = Selector pin fitted

✗ = Selector pin removed

Selector pin				Range	Displayed units
A	B	C	D		
✓	✓	✓	✓	1000	ppm (Default)
✓	✓	✗	✓	100	ppm
✓	✗	✓	✓	10	ppm
✓	✓	✓	✗	2280	mg/m ³
✓	✓	✗	✗	228	mg/m ³
✓	✗	✓	✗	22.8	mg/m ³

Selector pin 'B' and 'C' selects the ranges - 10 ppm, 100 ppm or 1000 ppm

Selector pin 'D' selects the units - ppm' or 'mg/m³

Selector pin 'A' - Fault output range

NOTE: During an Alarm condition (F1 or F2) the output will drop to either 3.5 mA or 2.0 mA.

Jumper 'A' fitted: 3.5 mA during an alarm condition

Jumper 'A' removed: 2.0 mA during an alarm condition.

As default, the TVOC has a 100 ppm factory calibration

TVOC setup

- NOTE:
- * TVOC is shipped with ALL selector pins fitted as standard
 - * TVOC only reads the selector pin settings when power is connected. Always ensure power is disconnected from TVOC before changing setting or carrying out maintenance.
 - * Never place selector pins on the programming port connector.
 - * Ensure static build up is discharged before touching components.
 - * If the jumper selection is not a recognised option then error F4 will occur. To recover switch the instrument off perform the correct jumper selection and switch the instrument back on.

Duty Cycle

The life of a photoionization lamp is used up when the lamp is illuminated, the lamp window can also contaminate resulting in a reduced level of detection. The TVOC pulses the lamp on and off which extends lamp life and reduces lamp contamination. This in turn can increase the time between servicing.

The TVOC switches on the lamp, takes a reading and then updates the 4-20 mA output and display screen. The default Duty Cycle is the frequency between test cycles, the factory default is set to 1 minute however this time can be adjusted from 0 to 5 minutes.

Please note: When bump testing after a calibration the response may be delayed depending on when in the gas is applied during the test cycle.

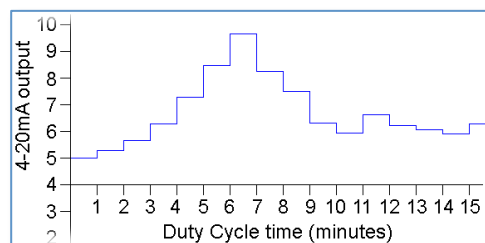

Fast response mode

The TVOC can be set to Fast Response Mode, when selected the TVOC will update the output every one second. Fast response mode can be selected by setting both the seconds and minutes to zero.

Please note: The warrantee of Ion Science PID lamps is based upon a duty cycle of 1 minute. Lamps used with Duty Cycle below one minute will not be covered under the standard warrantee terms.

Installation

Location

There are many variables involved in defining the optimum location for a gas detector. Obvious though it may sound, the most important rule is:

- A detector will not detect gas unless gas actually reaches the detector.
- TVOC should be mounted in the location most likely to detect gas.
- TVOC must be mounted vertically with the sensor underneath the case. This avoids dust and debris blocking the access to the detector cell.
- If possible, mount TVOC near the ceiling to target VOC gases that are lighter than air or just above floor level to detect VOC gases that are heavier than air.
- Mount TVOC in an area that has good air circulation. Restricting natural air current may result in delayed detection.
- Never mount TVOC in direct sunlight or over a heat source such as a radiator. This may cause TVOC to exceed its certified working temperature range.
- Do not mount TVOC in areas likely to flood.
- Mount TVOC's in areas that are easily accessible for servicing.
- Percentage variations in the composition of air (78% Nitrogen, 21% Oxygen and 1% Argon) may affect the detected signal.

Please refer to the technical specifications of the instrument under Technical Specifications of this manual before beginning a TVOC installation.

Cable and gland requirements

The Screw terminal sockets for connecting wires in the TVOC accept wires of 0.5mm² to 2.5mm² C.S.A.

Screened cables for both power and signal out are necessary to achieve EMC compliance. Cable screens must be terminated at both ends for them to be effective in achieving electromagnetic compatibility (EMC). The screens should be terminated to the TVOC enclosure using EMC compatible cable glands. It is important for an EMC compatible gland to make electrical contact to the enclosure. This is usually done using a serrated washer or EMC lock nut that bites through the paint making electrical contact. EMC lock nuts have been provided. These locknuts are orientation specific the points should be facing against the case in order to cut through the paint during tightening.

Two M20 cable glands and one blanking plug have been supplied as standard to ease installation in most circumstances. These parts will not be appropriate for all applications so they should be used at the discretion of the installation engineer. It is recommended that the manufacturer's instructions are followed for the gland and blanking plug installation. The M20 blanking plug has been included to enable installations using a single entry cable (for example a three wire system) to be implemented.

While Ion Science can not recommend the cable gland suitable for every application the following information may be useful to the installation engineer for the selection of the appropriate cable gland.

- For intrinsically safe operation using safety barriers, the only requirements on the cable glands are that they are better than IP20 rated. This may seem extraordinary however where the power is safely limited to the TVOC it is intrinsically safe so does not rely on the prevention of dirt or moisture into the enclosure.
- For intrinsically safe operation in Zone 2 without safety barriers, cable glands must be ATEX or IECX rated (Ex e, Ex n or Ex d) and at least IP54.

Installation of the TVOC depends on preferences of the installer, intrinsically safe operating legislation and the application.

Ion Science suggests connecting the screens from cables via a gland as shown on the diagrams and under Installation Section of this manual. There may however be technical circumstances where connection to the PCB is necessary.

Installation

Dimensions for mounting

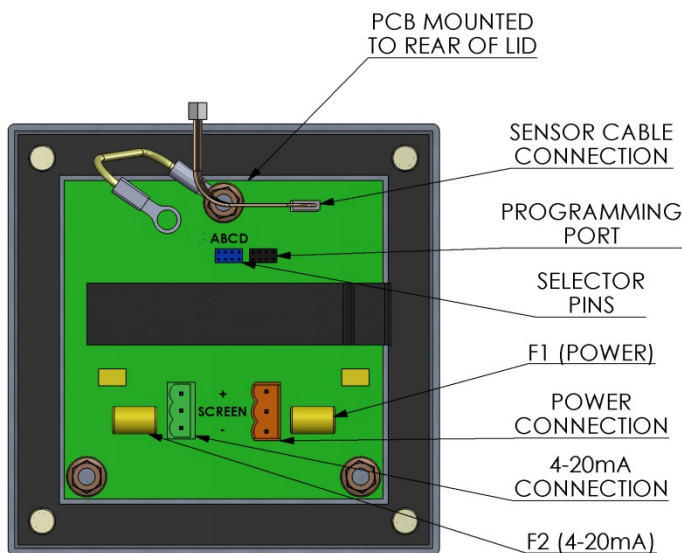
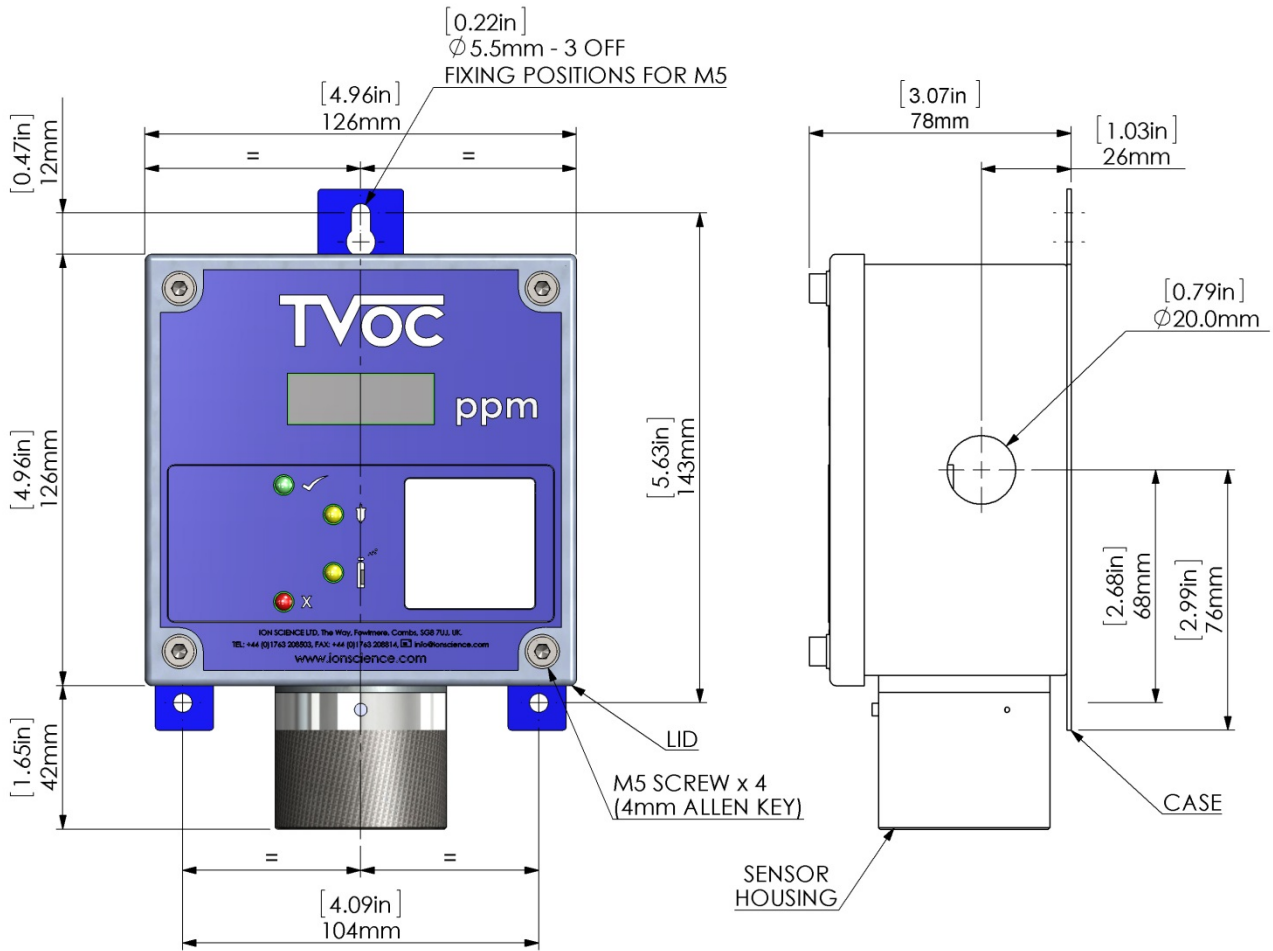

LID OPENED BY REMOVING M5 SCREWS. SENSOR & EARTH CABLE REMAIN CONNECTED TO CASE. LID MUST BE ROTATED DOWN OR TO ONE SIDE AND HANGS IN POSITION SHOWN.

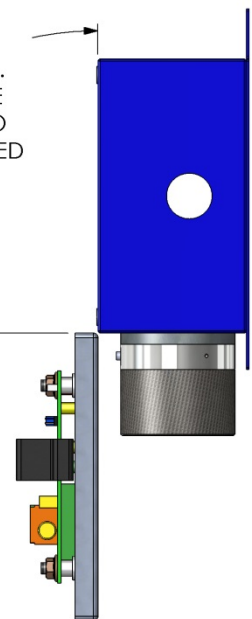

Diagram 5

Installation

NOTE: The TVOC case can be used as a template when marking out fixing holes but do not drill through the fixing holes.

Power requirements

Non Intrinsically Safe Operation applications:

Input power 5-28 Vdc. 80 mA max. (0.5 to 2.5 mm² C.S.A.)

Output power (4-20mA) 8-35 Vdc. 80 mA max. (0.5 to 2.5 mm² C.S.A.)

Note: 4-20mA loop must be externally powered.

4 Wire System
(Non IS)

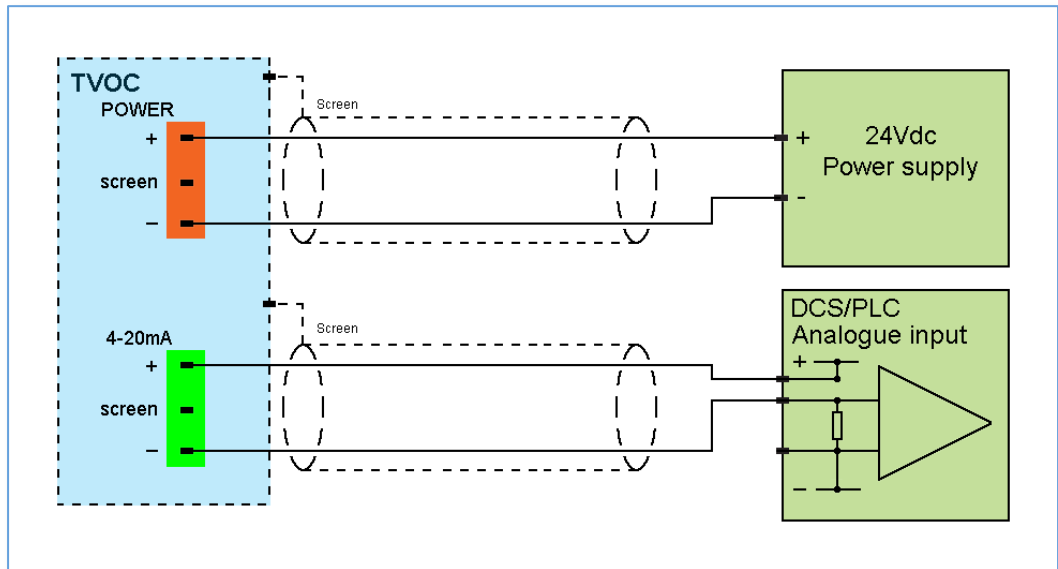

Diagram 6

3 Wire System
(Non IS)

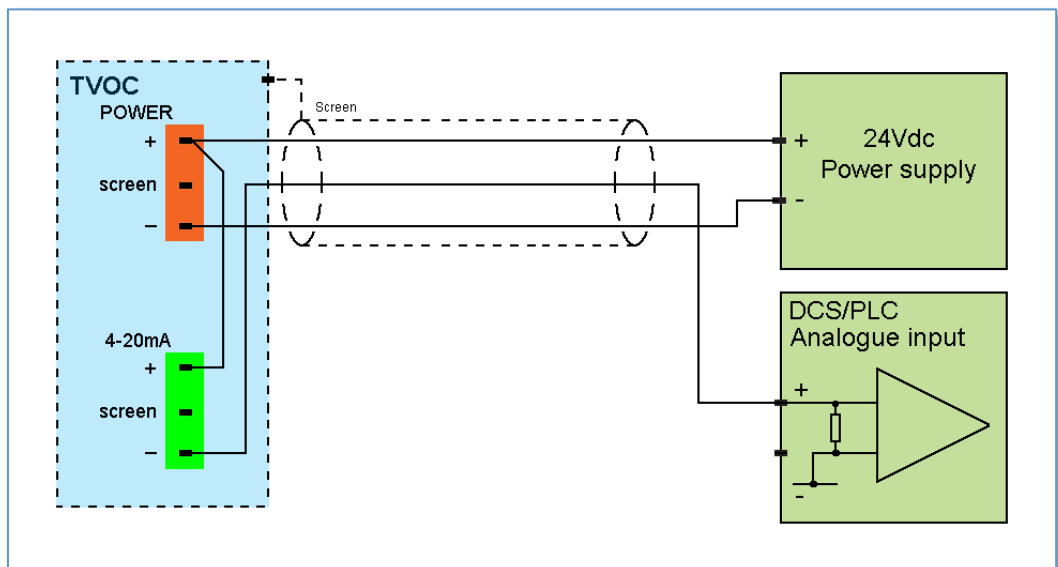

Diagram 7

Installation – Hazardous location

Warning!

The label on the enclosure details the IS and nA certifications. The appropriate section of the Intrinsically Safe label should be covered up or blocked out to reflect the type of installation. For Non-intrinsically Safe applications the label should be covered completely. For Intrinsically Safe (IS) Zone 2 applications with out safety barriers the ia certification details should be blanked out. For Zone 1 or Zone 2 IS applications with safety barriers the nA certification details should be covered. This will prevent safety discrepancies and or mis-use in the future should the equipment be moved or the site be re-defined as a hazardous area.

Entry parameters for intrinsically safe Zone 2, nA (non-sparking) areas only:

Input power	5-24 Vdc, 80 mA max
Output power (4-20 mA)	8-35 Vdc, 22 mA

For information only: please see Intrinsically Safe operation certificate before installation.

The wiring of Intrinsically Safe systems is identical to the wiring showing for non Intrinsically Safe applications. The only difference is the requirements to ensure that the power supplied used provides 24 V or less in normal operation.

Intrinsically Safe (IS) applications:	Entry parameters				
Input power	Ui = 18V	Ii = 800mA	Pi = 1.2W	Ci = 0µF	Li = 0mH
Output power(4-20mA)	Ui = 30V	Ii = 200mA	Pi = 1.2W	Ci = 0µF	Li = 0mH

For information only please see Intrinsically Safe certificate before installation

Ion Science Ltd suggest using the following zener barriers for IS approved applications. Use competent installation engineers and ask them for installation and application advice.

Note

- All cable lengths are estimated for Zone 1 IIC installation of the equipment
- Using 1 mm² C.S.A conductor S.T.P cables with capacitance per meter of 250 pF/m, L/R ratio of 25 µH/Ω conductor resistance at 20°C of 18.4 Ω/km.
- Calculation assumes cables are at 50°C.

Warning! Intrinsically Safe (IS) applications

- Units should not be powered using non IS power supplies prior to installation in an IS application.
- If non IS power is supplied the unit will require inspection by Ion Science Ltd or an Ion Science Approved Service Centre prior to installation in an IS application.
- TVOC fuses may not be replaced in the field.
- If a fuse is blown TVOC will require inspection by Ion Science Ltd or and Ion Science Approved Service Centre before it is used in an IS application.

Installation – Hazardous location

4-wire Control equipment sensing 4 – 20 mA on return line

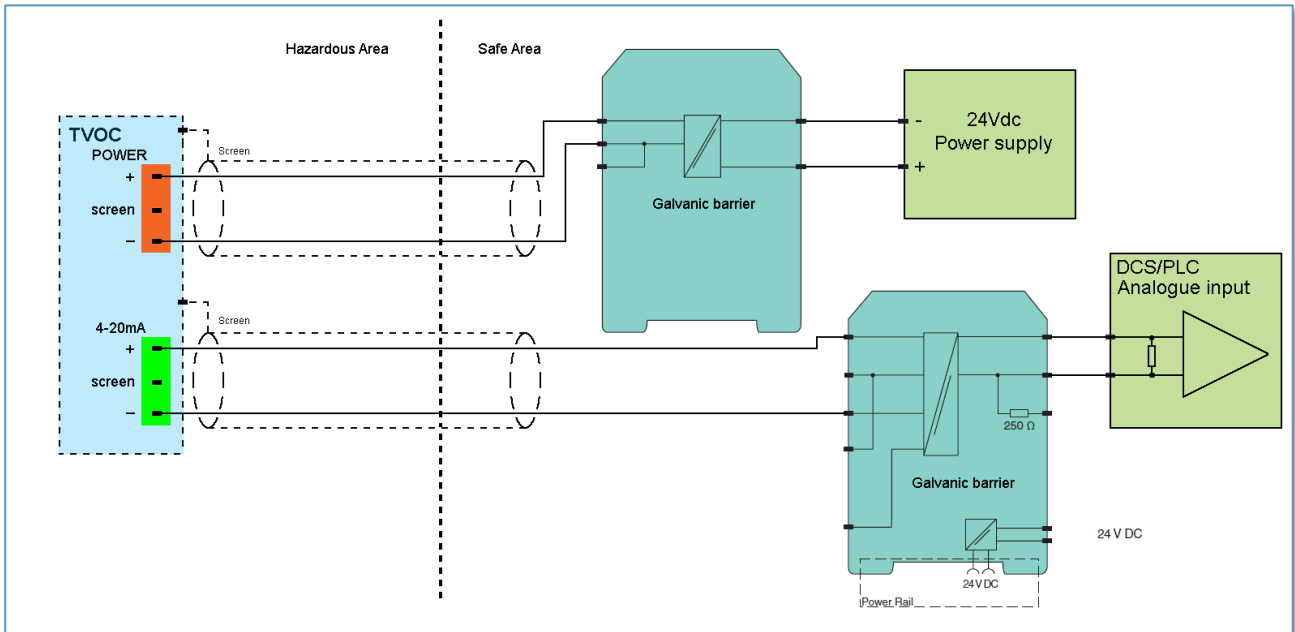

Notes:
Diagram 8

- For intrinsically safe installations, the enclosure may be opened while the system is live, provided the work is undertaken by competent personal and suitable safety precautions are taken. This overrides the warning on the enclosure label.

Initial calibration

TVOC is calibrated at Ion Science before dispatch using 100 ppm Isobutylene. However, if you wish to calibrate your TVOC after installation, Ion Science recommends that the TVOC is left to run on its chosen settings (see 'TVOC Setup Section') for 24 hours before an initial calibration is carried out, to allow the instrument to stabilise.

Operation

Start Up

After electrical power is connected, TVOC runs through a 'Start up' routine, which lasts for approximately 1 minute. During this 'Start up' routine TVOC demonstrates the following characteristics:

- * The LCD screen displays the software version number
- * The GREEN LED flashes
- * The 4-20 mA output is set to 4 mA (0.0 ppm)

NOTE: If the 0-10 ppm range is selected the TVOC will require calibration using 10ppm Isobutylene before use (See the calibration section of this manual)

During this 'Start-up' time the user can adjust the Duty Cycle time as referred to in 'TVOC Setup' under the Duty Cycle section. This time can be adjusted from 0 to 5 minutes in 10 second increments.

Adjusting the Duty Cycle

NOTE: Please read this entire procedure before attempting to adjust the lamp OFF time.

There are two stages to adjusting the Duty Cycle time. The first stage adjusts the seconds 0 to 59 seconds, the second stage adjusts from 0 to 5 minutes. Please see the description of the Duty Cycle on page 10.

1. During the 1 minute 'Start up' time place the calibration magnet over the top right hand corner of the Ion Science logo. (See diagram 9) Two numbers on the right of the LCD screen will flash.



Diagram 9

2. While the magnet is held in this position the number on screen will roll over from 00 through to 50 in 10 second steps. Quickly remove the magnet when the desired time appears.



3. After 5 seconds the TVOC will move on to the next stage. (Reapply the magnet within 5 seconds if further adjustment is necessary)

4. The TVOC will move to the next stage indicated by a digit appearing on the left of the screen. Holding the magnet in place will cause this number to roll over from 0 to 5 minutes. Quickly remove the magnet when the desired time appears.

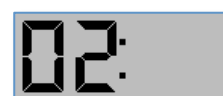

5. After 5 seconds the TVOC will display both the minutes and seconds selected. (Reapply the magnet within 5 seconds if further adjustment is necessary)



6. TVOC will restart the start-up sequence and then enter running mode. The Duty cycle is then saved to memory. The duty cycle will be remembered through a power cycle.

Fast response mode

If the Duty Cycle time is adjusted lower than 0:10 (10 seconds) the instrument will update the output every one second. In this mode of operation the F2 fault condition is disabled. This means that removal of the sensor may go undetected.

Operation

LED's

see *Diagram 12*

The green indicates TVOC's working status:

ON	Indicates the PID lamp is OFF
Flashing	Indicates the PID lamp is ON

A red indicates fault status:

ON	Indicates TVOC cannot function correctly. The 4-20mA output drops to 3.5mA. URGENT attention is required.
Flashing	Indicates the TVOC cannot function but a reading is being attempted

A yellow Zero LED indicates during normal operation

ON	Last calibration zero level was outside expected limits (The instrument will operate normally with the previous calibration)
----	---

A yellow Span LED indicates during normal operation

ON	Last calibration Span level was outside expected limits (The instrument will operate normally with the previous calibration)
----	---

Please see *Section 7 Calibration for YELLOW LED status.*

Selector pins

TVOC has a range of options that are selected via the selector pins on the back of the main PCB (please see the 'TVOC Set up' Section).

The options are shown below with the defaults highlighted in bold:

1-1000 ppm	or	0.01 – 10 ppm or 0.1 – 100 ppm
ppm units	or	mg/m ³ units

Calibration mode

TVOC calibration mode can be accessed using the calibration magnet supplied in the TVOC calibration tool kit (Part number: A-845214).

To enter calibration place the magnet over the top right of the Ion Science Logo until the state changes (i.e. an LED illuminates and/or the display changes).

Ensure the magnet is withdrawn away from the magnetic switch by at least 1 cm once a change has occurred.

Calibration gases

TVOC has three (3) ranges that can be selected however the 0-10ppm range requires the instrument is calibrated by the user before use. The 0-100ppm and the 0-1000 ppm ranges can initially run using the Factory calibration carried out during the instruments manufacture, however because the 0-10 ppm range is more sensitive and more susceptible to environmental and system tolerances the instrument must be calibrated before use.

If the 0-10 ppm range is selected TVOC will display the following screen to indicate that a calibration is required before it can be used. Follow the calibration instructions before use.

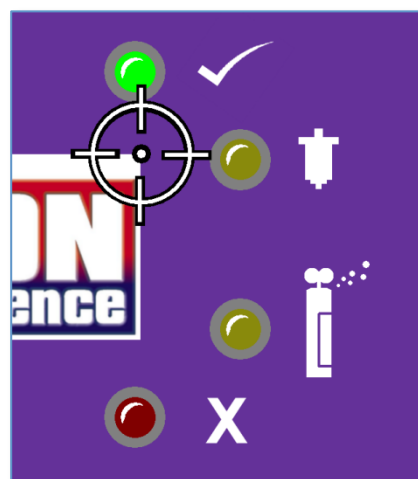

Diagram 10

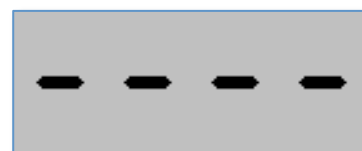

Diagram 11

Calibration

Calibration routine

Ion Science recommends calibrating TVOC after any maintenance or lamp cleaning is carried out and on a 3 monthly basis to ensure TVOC is working to specification.

NOTE: Please read this entire calibration procedure before attempting a calibration.

TVOC calibration is undertaken in four steps:

1. Setting the ZERO (Using clean gas via carbon filter)
2. Setting the gas tolerance (1 – 200 ppm Isobutylene on 0-100 ppm and 0-1000 ppm ranges)
(0.1 – 20.0 ppm Isobutylene on the 0-10ppm range)
3. Setting the SPAN (Using the SPAN gas)

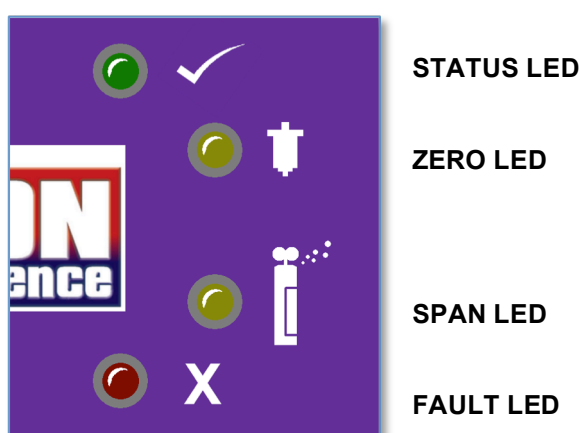

Diagram 12: LED's
STATUS, ZERO, SPAN, FAULT

Setting the ZERO

- 1 – Place the calibration magnet over the top right hand corner of the Ion Science logo to enter calibration mode. *The 'ZERO LED' will illuminate and the 'STATUS LED' will extinguish.*
- 2 – Remove the calibration magnet
- 3 – Insert the calibration adaptor into the sensor cap, attach the carbon filter to the calibration adaptor. The carbon filter should be attached to the hand aspirator.
- 4 – Again place the calibration magnet over the logo. *The 'ZERO LED' will flash, during this stage TVOC displays a direct millivolt (mV) output from the PID sensor.*

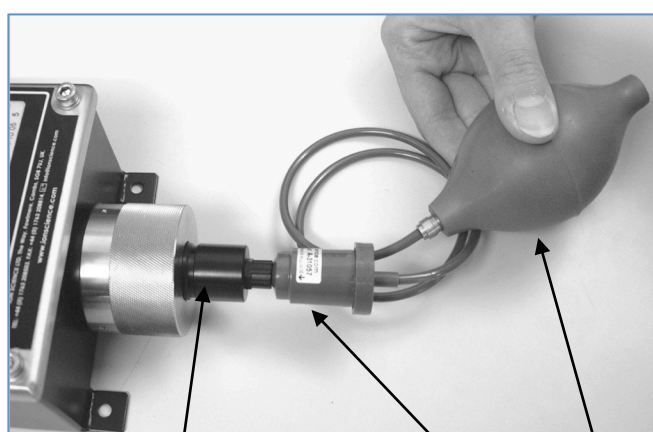

Diagram 13

Calibration adaptor

Carbon filter

Hand aspirator

Calibration

- 5 - Slowly and repeatedly squeeze the hand aspirator to push clean air through the carbon filter and past the PID sensor. The 'ZERO LED' will stop flashing after approximately 2 minutes.
- 6 – Now remove the equipment except for the calibration adaptor.

NB During the above process the 'mV' reading on the display must fall below 30 mV to pass the Calibration stage.

An acceptable ZERO calibration level will result in the illumination of the 'STATUS LED'.

An unacceptable ZERO calibration level will result in the illumination of the 'FAULT LED'. Should this occur the TVOC will not proceed to the gas tolerance setting and return to normal operation the previous calibration levels will be used. The Yellow 'ZERO LED' will be illuminated to indicate the failure to set a zero calibration level.

Setting the gas concentration (The actual value that the calibration has been supplied at)

- 1 Now, again place the calibration magnet over the corner of the logo – *The GREEN or FAULT LED will be extinguished and the numeric display will start to flash.* 
- 2 If the 0-10ppm range is selected you will be able to adjust between 1.0 ppm and 100ppm, for both the 100 ppm and 1000 ppm ranges a concentration of between 1 and 200 ppm can be selected. Leaving the magnet in position will cause the displayed number to cycle through the concentration, remove the magnet when the displayed value matches that stated on the Calibration gas bottle. Should you miss the desired reading quickly reapply the magnet to continue scrolling through the numbers and remove the magnet at the desired figure. The selected number will be recorded 5 seconds after the removal of the magnet when the display stops flashing. The display will initially show 90, should this be the desired figure remove the magnet straight away.

Setting the SPAN

- 1 Connect the SPAN gas to the calibration connector then the connector to the adaptor. Do not over tighten the Luer fitting; only a one quarter turn is required. Switch on the gas supply and then place the magnet over the logo.

The SPAN LED will flash and TVOC will display the direct millivolt (mV) output from the PID sensor. Now remove the magnet.

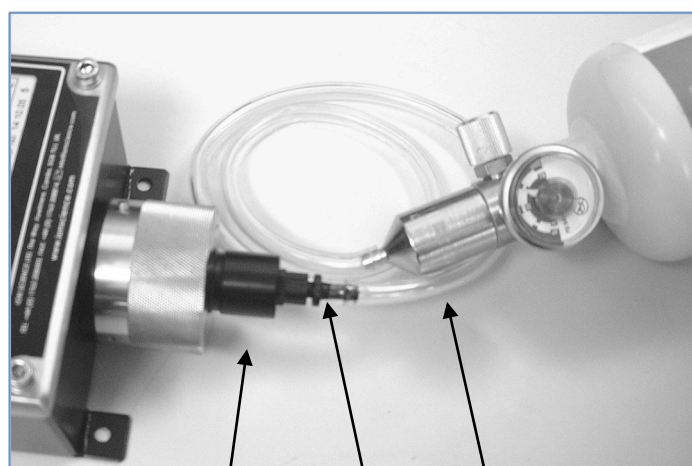

Diagram 14

Calibration adaptor

SPAN gas

Calibration connector

- 2 The SPAN LED will stop flashing after approximately 2 minutes.
- 3 Turn off the gas and disconnect the equipment

Calibration

NB during the span measurement process the mV reading of the span must be greater than the zero level to pass the ZERO calibration stage.

*An acceptable SPAN calibration level will result in the illumination of the green STATUS LED.
An unacceptable SPAN calibration level will result in the illumination of the red FAULT LED. Should this occur the previous calibration levels will be used when the instrument returns to normal operation. The Yellow span LED will be illuminated to indicate the failure to calibrate the span.*

Now place the magnet over the logo corner to return to normal monitoring routine.
The GREEN LED will start flashing as TVOC starts its cycle with a lamp ON cycle.

IMPOTANT: Unacceptable calibration levels will not be adopted; the instrument will default to the previously stored acceptable calibration factor.

NOTE:

- * Always check the accuracy of your calibration by checking readings from TVOC when it is running normally using the ZERO filter and SPAN gas.
- * Accuracy of calibration is the responsibility of the person carrying out the calibration. If in doubt seek advice.
- * TVOC must be calibrated after lamp/cell cleaning or general maintenance.

NOTE: Causes of contamination and error in signal:

- * Changes in air pressure when detecting ppm concentration
- * Variation in oxygen, argon beyond ambient levels.
- * Variation in ambient moisture content.

Maintenance

Cleaning / replacing the lamp

TVOC has been designed to ensure servicing is quick and easy:

1. Before servicing TVOC, disconnect the electrical power supply.
2. Remove the locking screw from the metal sensor cap using the Allen key supplied within the Calibration tool kit. (part number A-849214)

Warning:

Failing to remove the locking screw before unscrewing the *sensor cap* will damage the sensor holder.

3. Unscrew the *sensor cap* to access the PID sensor.

4. Remove the PID Sensor by withdrawing it from the *sensor housing*. Only light force is required

Warning:

Do not twist the PID Sensor while it is within the *sensor housing*.

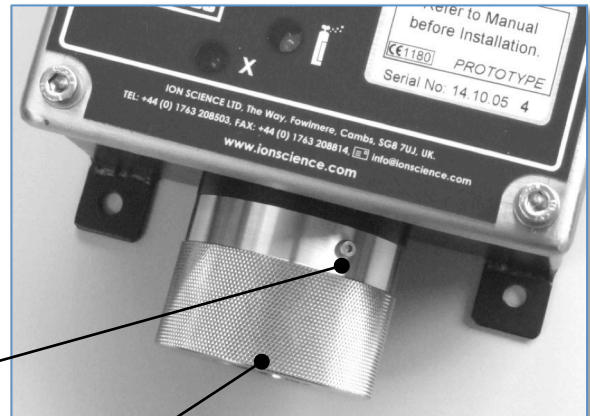

Locking screw

Diagram 15

Sensor cap

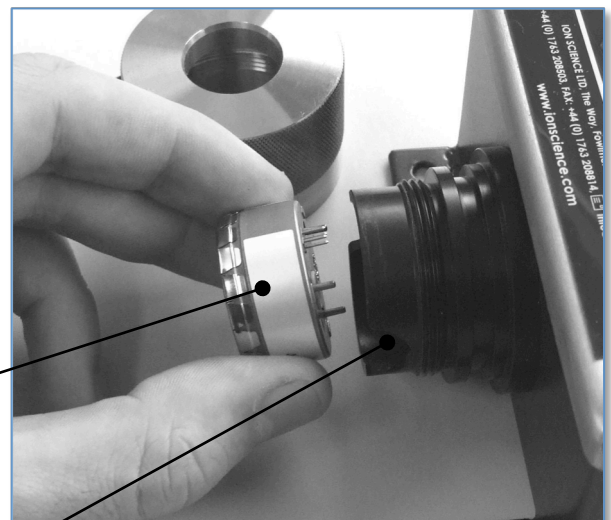

PID sensor

Sensor housing

Diagram 16

Maintenance

5. The PID sensor's *metal spring cover* can be pulled off using moderate force. The *electrode stack* and *PID lamp* can then be removed by holding the *PID sensor* upside down.

Warning:

Ensure the *electrode stack* and *PID Lamp* falls onto a soft surface such as a piece of tissue. This will avoid damaging the parts as they fall out and avoids finger contact with the *PID lamp* window.

6. Clean the *PID Lamp* using *Alumina powder* loaded onto a *cotton bud*. Rub the *cotton bud / Alumina powder* on the *PID lamp window* using a circular motion until a light audible squeak can be heard.

NOTE:

Contamination of the *PID Lamp window* can considerably reduce the detection capability of the *PID cell*, even when the contamination is not visible.

Cleaning of the lamp should be carried out on a regular basis depending on the duty cycle of the *PID lamp* and the environment.

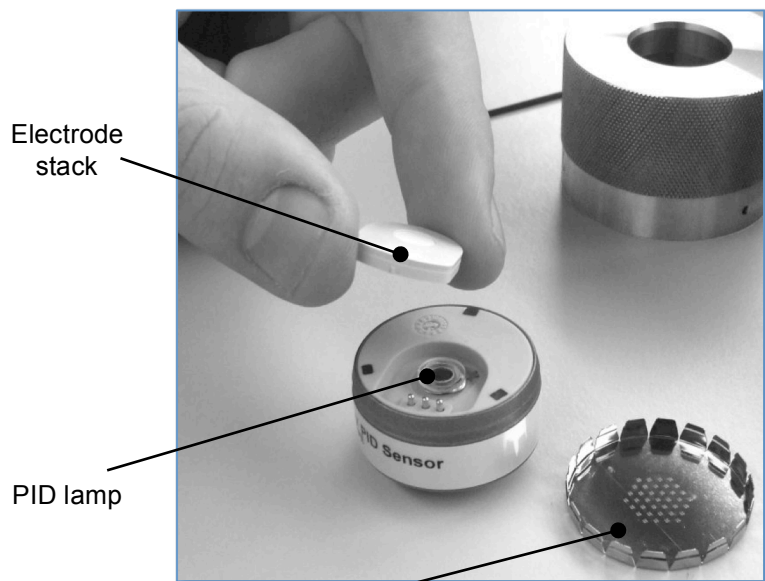

Electrode stack

PID lamp

Diagram 17

Metal spring cover

Cotton bud / Alumina powder

Alumina powder

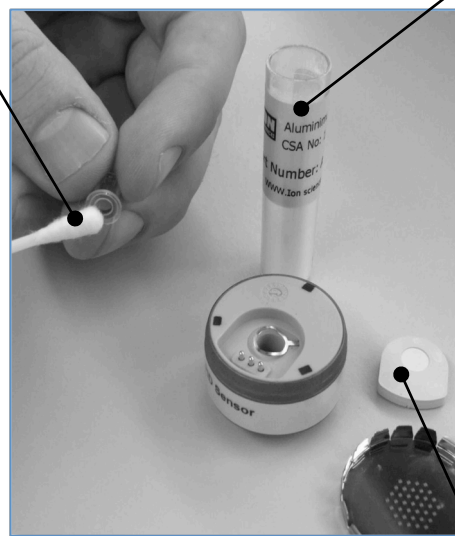

Diagram 18

Pellet

Maintenance

The humidity of the air and contaminants may affect the time required between servicing.

Warning:

7. *The Electrode Stack* should be inspected for visible signs of contamination, if contamination can be seen the Stack it must be replaced. (part number 1/EA-02)

Reassembly:

8. Place the clean PID Lamp into the PID Cell avoiding finger contact with the Window.
9. Refit the *electrode stack* with the electrical pin holes and electrode contacts facing down.
10. Refit the *metal spring cover*.

11. Ensure the *electronic pins* of the *PID sensor* are at the 12 o'clock position before inserting the *PID sensor*.

The PID sensor should insert into the connectors easily, if significant resistance is felt, remove the cell and check alignment before reinserting.

Electronic pins

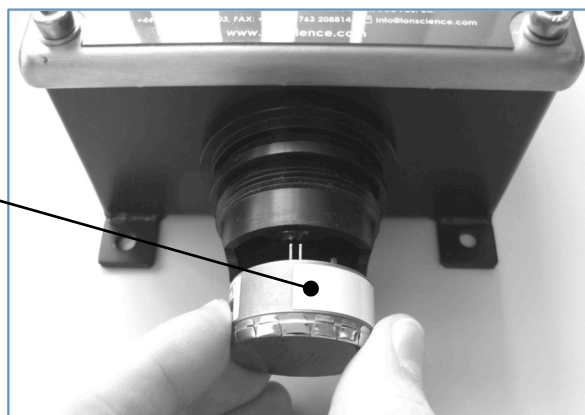

Diagram 19

Warning:

Irreparable damage will be caused by forcing the PID into the *sensor housing* if not correctly aligned.

NOTE: Always calibrate TVOC after servicing is carried out.

Fuse rupture and replacement

TVOC has a 125 mA BASEEFA certified fuse to provide intrinsically safe protection when the unit is installed in hazardous areas.

This fuse may rupture for example due to over voltage or a current surge, if this is the case replacement is different depending upon the application being intrinsically safe (IS) or not.

For IS applications the unit must be inspected and have the fuse replaced by Ion Science Ltd or an Ion Science Approved Service Centre. The intrinsically safe rating is not maintained if the fuse is simply replaced.

For non-IS) applications the fuse may be replaced by an equivalent rated fuse and operation tested by qualified engineering personnel.

Lamp Warranty Statement

Please note: The standard warranty period for a 10.6 PID lamp is one year, providing that the default duty cycle for lamp is set to 1 minute of greater.

System recommendations

TVOC is generally used to measure gas concentrations in the ambient atmosphere. The sensor is open to the atmosphere and any gas that diffuses or moves under convection into the locality of the TVOC sensor will be detected. Generally, the ambient environment in which TVOC is located is readily accessed, but there are applications listed below that require special consideration.

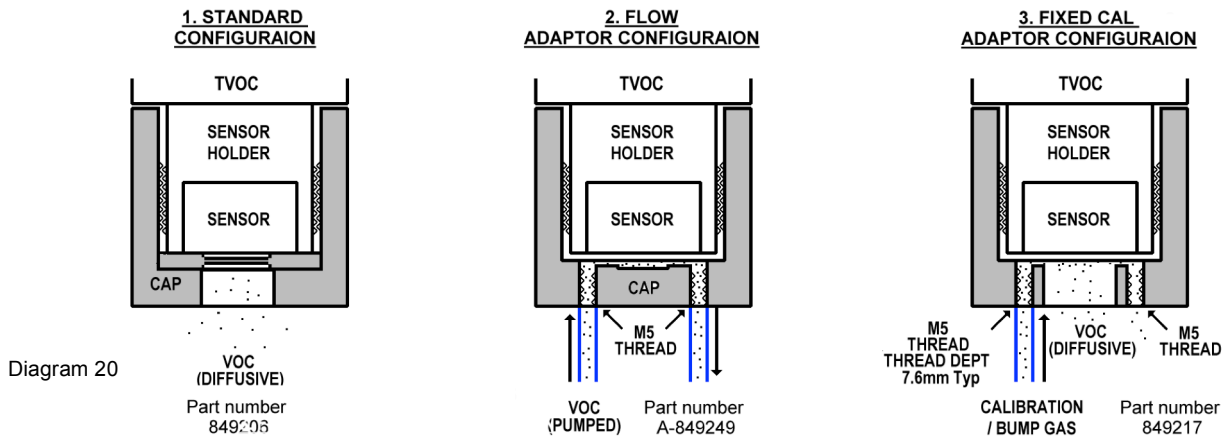

Remote area monitoring

TVOC may be placed in a roof or other space that is hard to access but where the TVOC requires regular bump tests. In this event, TVOC can be fitted with a *Fixed calibration adaptor*, Diagram 22. A flow adaptor is also available for remote testing.

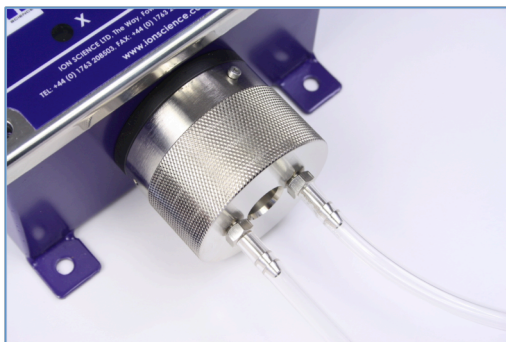

Diagram 21

Fixed calibration adaptor

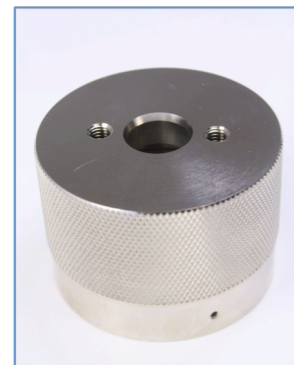

Diagram 22

Gas sample systems

It is sometimes necessary to pump or draw a gas sample past the TVOC. For this a "Flow Adaptor" can be fitted. The flow adaptor has an inlet and an outlet port so that gas may be pushed or drawn across the sensor. See diagram 2 above.



Diagram 23

TVOC Flow Adaptor
5/JHS-01



Diagram 24

System recommendations

For a gas sample system we have the following recommendations:

1. Where possible use the Flow Adaptor (as described above) that is sold by ISL. This has an integral o-ring to seal the sensor housing and ports for connection of inlet and out let sample tubes. Please refer to Spare parts section for part number.
2. The pressure difference of a pumped system relative to atmosphere should be minimised to avoid the effects of gas law.
3. The maximum pressure that can be applied to the TVOC sensor housing is 300 mbar. However this is not a recommended working pressure. Ideally working pressure should be +/- 30 mBar relative to ambient pressure.
4. In line flow restrictions must be minimized. Flow restrictions cause differential pressures which can directly affect the TVOC ready. If flow restrictions are unavoidable the flow rate should be lowered to minimize the pressure effects, this however will increase the response time.
5. A flow between 250 and 500 ml/min is recommended for calibration. This will ensure a full response to applied gas in a sensible time.
6. The working flow should be very similar to that use to calibrate the instrument or errors in output will occur (see point 2).
7. The response time of the system is defined by the sensor response rate and sample flow rate will in combination with the tube length and diameter as well as any dead volumes.

Instrument warranty and service

Warranty

Standard Warranty can be extended to up to 2 years on the TVOC when registering your instrument via our website: www.ionscience.com/instrument-registration

To receive your Extended Warranty, you need to register within one month of purchase (Terms and Conditions apply). You will then receive a confirmation email that your Extended Warranty Period has been activated and processed.

Full details, along with a copy of our Warranty Statement can be found by visiting: www.ionscience.com/instrument-registration

Service

Ion Science is pleased to offer a number of service options on our TVOC product range that allow you to choose the instrument cover that best suits your needs.

At Ion Science we recommend that all of our gas detection instruments be returned for service and factory calibration once every 12 months.

Contact Ion Science or your local distributor for service options in your area.

Find your local distributor by visiting: www.ionscience.com

Contact details

UK Head Office

Ion Science Ltd
The Way, Fowlmere
Cambridge
SG8 7UJ
UK
Tel: +44 (0)1763 207206
Fax: +44 (0) 1763 208814
Email: info@ionscience.com
Web: www.ionscience.com

USA Office

Ion Science LLC
4153 Bluebonnet Drive
Stafford
TX 77477
USA
Tel: +1 (877) 864 7710
Email: info@ionscienceusa.com
Web: www.ionscienceusa.com

German Office

Ion Science Messtechnik GMBH
Laubach 30
Metmann-Neandertal
40822
GERMANY
Tel: +49 2104 14480
Fax: +49 2104 144825
Email: info@ism-d.de
Web: www.ism-d.de

Italian Office

Ion Science Italia
Via Emilia 51/c
40011 Anzola Emilia
Bologna
ITALY
Tel: +39 051 0561850
Fax: +39 051 0561851
Email: info@ionscience.it
Web: www.ionscience.it

Diagnostics

Below are two conditions your TVOC can be in when it is working correctly:

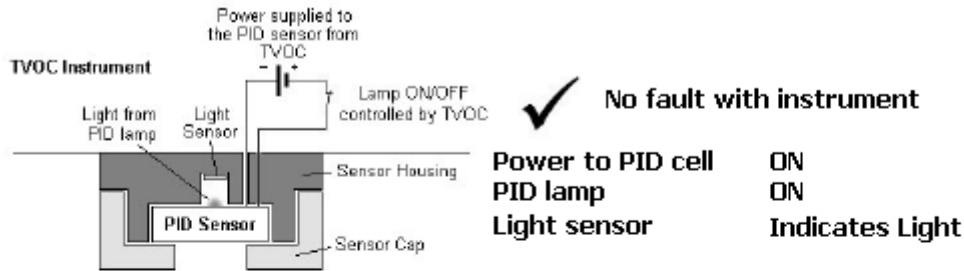

Diagram 25

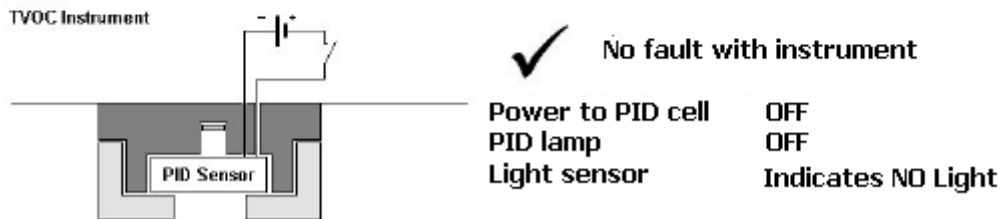

Diagram 26

The two conditions shown below are of the instrument in an error state with potential checks/cures for these faults:

If an F1 error occurs when the instrument is first switched on there may not be an issue. The instrument needs to be left on for a few cycles to see if the lamp strikes on its own. If an F1 error, as shown below, is displayed when the instrument is still on screen after 5 minutes then look at the information below

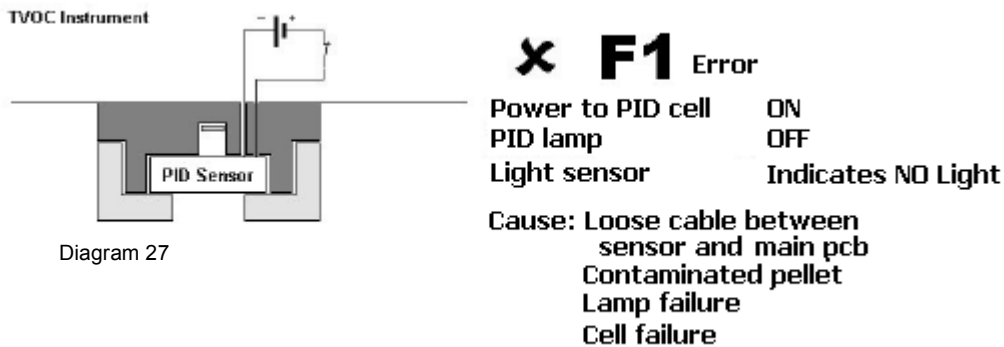

Diagram 27

If the F1 error persists for more than 5 minutes, firstly check the red cable between the sensor PCB and the main PCB is securely connected. The red cable is sufficiently rigid to be gripped inside the case and pushed into the sensor housing. Instruments with serial numbers exceeding 10-1790 include an improved connection and diagnostic fault F3 which indicates if this connection has failed.

Diagnostics

If the F1 diagnostic persists, replace the sensor electrode stack, part number 1/EA-02, re-power the instrument and wait 5 minutes. If the F1 error continues, replace the sensor lamp, part number 833229. Pellet and lamp spares are identified in.

If the instrument continues to exhibit the F1 failure after replacement of parts please contact your Ion Science distributor.

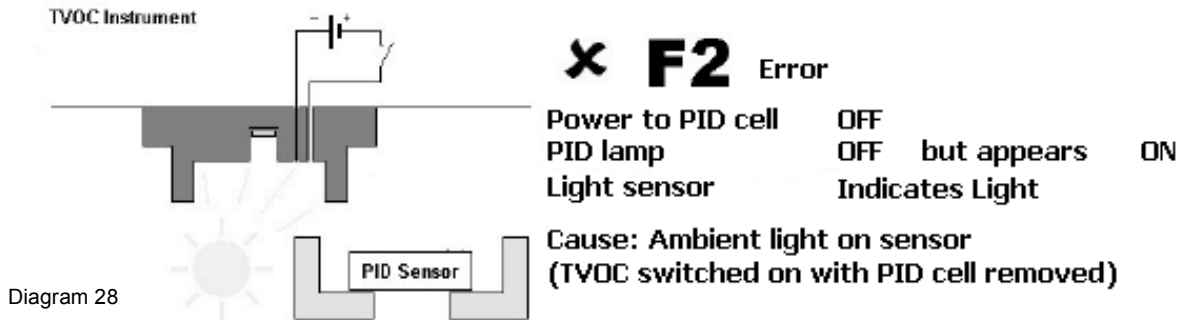

The F2 error occurs when the lamp appears to be illuminated yet power is removed from the PID sensor, TVOC checks the PID lamp status using a light sensor. Running TVOC with the sensor or the sensor cap removed will result in an F2 error.

Please note: The F2 error is disabled when the duty cycle is set below 10 seconds.

A light guard is fitted within the PID sensor housing. This ensures the light sensor is unaffected by ambient light.

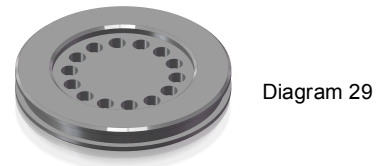

IMPORTANT:

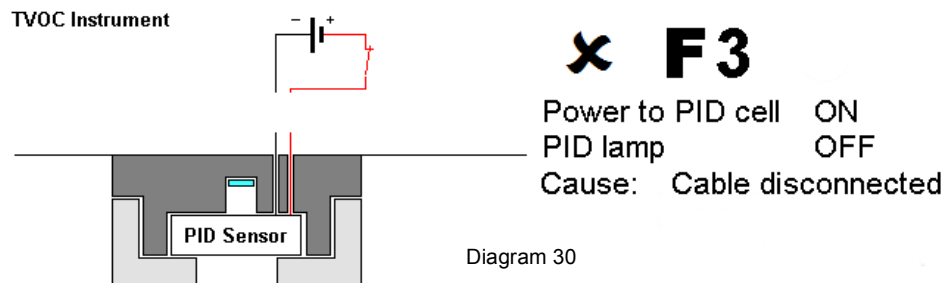

The F3 error occurs when the sensor is disconnected from the power supply. Instruments with serial numbers earlier than 10-01790 will not indicate an F3 error if the cable. Instead, an F1 error will be displayed instead and the diagnostics associated with F1 errors, as above, should be performed.

If an F3 error occurs then check the cable is properly connected to the main PCB. If not push it fully home.

F4 errors

The F4 error occurs when an incorrect jumper cable selection is used, see *TVOC Set up*.

Spare parts

Part	Description	Part number
Calibration tool kit	Calibration magnet, Calibration adaptor, Calibration connector, Zero gas aspirator, Carbon filter, 2 x Allen keys.	A-849214
Flow adaptor	Replaces the standard Sensor Cap (Allows an external pump to be fitted as Shown in diagram below)	A-849246
Fixed calibration adaptor	Replaces the standard Sensor Cap (Allows an external pip connection as Shown in diagram below)	849217
PID Lamp cleaning kit	Alumina powder and cotton buds	A-31063
Span Gas kit (100 ppm)	100ppm Isobutylene (103Liters) and Flow Regulator in a carry case	A-845213
Span Gas kit (10 ppm)	10ppm Isobutylene (103Liters) and flow Regulator in a carry case	849230
PID sensor	Replacement PID Sensor	1/EO-2
Carbon filter	User for ZERO span	A-31057
Calibration magnet	User to step through calibration	A-849219
Electrode stack		1/EA-02
PID lamp		A-833227
Sensor light guard	Prevents bright light conditions causing False F2 alarms.	849245
O Ring for Sensor Light Guard	Fits to outside of Sensor Light Guard	5/OV-11
Calibration Adaptor	(Part of the Calibration toolkit) For connecting to the standard cap for calibration.	A-849209

Technical specifications

PID Sensor	With fence electrode technology				
Lamp type	10.6 eV (Krypton)				
TVOC enclosure ingress protection	IP65				
Sensor ingress protection	IP54				
Range	0 – 10 ppm / 0 – 22.8 mg/m ³ (0.01 resolution) 0 – 100 ppm / 0 – 228 mg/m ³ (0.1 resolution) 0- 1,000 ppm / 0 – 2280 mg/m ³ (1.0 resolution)				
Non IS applications	Input power	5 – 28 Vdc. 65 mA (0.5mm ² to 2.5mm ² C.S.A.)			
	4 – 20 mA power	8 – 35 Vdc. 22 mA (0.5mm ² to 2.5mm ² C.S.A.) 4-20mA loop must be externally powered			
ATEX approval	⊕ II 2G EEx ia IIC T4 (-20°C ≤ Ta ≤ +50°C)				
IECEx approval	Ex ia IIC T4 (-20°C Ta +50°C)				
Certificate number	Baseefa05ATEX0277				
IS applications	Entry parameters				
Input power	Ui = 18V	li = 800mA	Pi = 1.2W	Ci = 0µF	Li = 0mH
4-20mA power	Ui = 30V	li = 200mA	Pi = 1.2W	Ci = 0µF	Li = 0mH
For information only please see ATEX certificate before installation					
Zener Barriers:	Required Ask your installation engineers for installation/application advice.				
(Non sparking) approval	⊕ II 3G Ex nA IIC T4 (-40°C < Ta < +50°C) (nA for zone 2 only)				
Dimensions			Weight		
Height	188 mm	(7.40")	Instrument	1.3kg	(2.9 lb)
Width	126 mm	(4.96")	Packed	1.47kg	(3.2lb)
Depth	78 mm	(3.07")			
Display	7 Segment, 4 Digit LCD. 4 Colour LED's				
Response	Sensor T90 < 5sec				
Accuracy	TVOC output update: Variable 1 second to 10 minutes 0 to 100 ppm: +/- 1 ppm (whichever is greater) 100 to 1000 ppm: +/- 10% or +/- 10 ppm (whichever is greater)				
Linearity	0 – 1000 ppm >75%				
Calibration	Magnetically accessed ZERO = Carbon canister SPAN = 100 ppm Isobutylene +/- 10%				
Temperature	Operation: -20 °C to +50 °C (-4 °F to 122 °F)				
Humidity	0 – 95% RH (non-condensing)				
EMC	Screened cables are required to archive the light industrial immunity levels.				

NB: All specifications are against an isobutylene calibration at 20 °C, 90% RH and up to 100 ppm.

Manual log

Manual Version	Amendment	Date updated	Instrument Firmware	PC Software
TVOC Manual V2.1	Diagram 5.2.1 updated on page 11	31/3/08	V3.09	N/A
TVOC Manual V2.2	Diagram updated on page 15	21/4/08	V3.09	N/A
TVOC Manual V2.3	Declaration on conformity change only	27/11/08	V3.09	N/A
TVOC Manual V2.4	Log added to back of manual	09/01/09	V3.09	N/A
TVOC Manual V2.5	Diagnostics added and P&F barrier changed	20/02/09	V3.09	NA
TVOC Manual V2.6	TVOC firmware modified to allow customers to calibrate using an alternative concentration. Also improved the description of the F2 fault condition. (P6, P17, P24)	22/07/09	V3.10	N/A
TVOC Manual V2.7	TVOC ATEX certification to allow zone 2 installation without safety barriers. (P12, P13, P26)	1.09.09	V3.10	N/A
TVOC Manual V2.9	Inclusion of Cable gland in kit, so addition of details regarding cable gland selection and use Change to EMC details as result of testing	23.3.10	V3.10	N/A
TVOC Manual V3.0	Warranty Cover updated Declaration of Conformity updated Contents page updated Instrument Warranty and Service updated	22/07/10	V3.10	N/A
TVOC Manual V3.1	Addition of fault output level on page 9, Calibration fault LED indication changed on Page 20, 22, 23	07/08/10	V3.25	N/A
TVOC Manual V3.1	Addition of F3 and F4 fault to diagnostics section pages 27, 28, & 29. Additional notes in TVOC setup, selector pin section page 11	08/09/10	V3.25	N/A
TVOC Manual V3.1	Addition wire C.S.A areas accepted on pages 14 & 30 Mounting diagram 5.2.1 on page changed to general assembly drawing	06/10/10	V3.25	N/A
TVOC Manual V3.2	Page 9. Text amended to emphasise when TVOC is un-calibrated.	06/11/10	V3.25	N/A
TVOC Manual V3.4	Page 14. Barrier part numbers removed	20/12/10	V3.25	N/A

Manual log

TVOC Manual V3.5	Barrier details removed for technical specification, notes added that 4-20mA requires external power	14/01/2011	V3.25	N/A
TVOC Manual V3.6	Pages 3&4 updated to correct Quality Management System Page 5 Responsibility of use updated an legal notice added Page 18 Setting the gas tolerance changed to '0.1 – 20.0' to reflect instrument function. Page 24 & 25 System Recommendations added. Page 26 contact details moved here Page 28 details of Sensor Light Guard added. Page 29 Parts notes updated. Pages 7,11,13 & 14 ATEX comments changed.	23/03/11	V3.27	N/A
TVOC Manual V3.7	Page 30 – Accuracy and Linearity specifications updated	15/03/12	V3.27	N/A
TVOC Manual V3.8	IS wiring diagrams and photos updated.	24/05/12	V.3.27	N/A
TVOC Manual V3.9	Slight modification to installation instructions. Page 11, Point 7 Page 30, IP clarification	26/05/12	V3.27	N/A
TVOC Manual V4.0	Page 30, Accuracy specification only	29/10/2012	V3.27	N/A
TVOC Manual V4.1	Manual format and layout updated	07/01/2013	V3.27	N/A
TVOC Manual V4.2	Change to duty cycle. Pages 9, 10, 16 and 28	28/02/2013	V4.09	N/A
V4.3	Firmware now suitable for old and new product	09/07/2013	V4.11	N/A
V4.4	Certification updated Page 3 and various minor updates made through out to text , capitalisation , italics etc...	15/05/2014	V4.11	N/A
4.5	Removal of obsolete comment on red LED status on page 20.	14/08/2015	V4.11	N/A
4.6	Updated Certificate of Conformity Page 3	29/04/2016	V4.11	N/A